









Heating- and Heat Pump Control

Operating Instructions

Luxtronik

Controller part 1 (Customer & Qualified technician)

-  Program area "Info + Quick Setting"
-  Program area "Heating"
-  Program area "Domestic hot water"
-  Program area "Cooling"
-  Program area "Parallel connection"
-  Program area "Service"





Please read first

This operating manual provides important information on the handling of the unit. It is an integral part of the product and must be stored so that it is accessible in the immediate vicinity of the unit. It must remain available throughout the entire service life of the unit. It must be handed over to subsequent owners or operators of the unit.

Read the operating manual before working on or operating the unit. This applies in particular to the chapter on safety. Always follow all instructions completely and without restrictions.

It is possible that this operating manual may contain instructions that seem incomprehensible or unclear. In case of questions or uncertainty, contact the factory customer service department or the manufacturer's local service partner.

This operating manual is intended only for persons assigned to work on or operate the unit. Treat all constituent parts confidentially. The information contained herein is protected by copyright. No part of this information may be reproduced, transmitted, copied, stored in electronic data systems or translated into another language, either wholly or in part, without the express written permission of the manufacturer

Symbols



Information for operators.



Information or instructions for qualified technicians and authorised service personnel.



DANGER!

Indicates a direct impending danger resulting in severe injuries or death.



DANGER!

Indicates danger of fatal injury due to electric current!



WARNING!

Indicates a possibly dangerous situation that could result in severe injuries or death.



CAUTION!

Indicates a possibly dangerous situation that could result in medium or light injuries.



ATTENTION

Indicates a possibly dangerous situation, which could result in property damage.



NOTICE

Emphasized information.



ENERGY SAVING TIP

Indicates suggestions that help to save energy, raw materials and costs.



Users and qualified technicians can set data.



Authorized fitter can set data; password required



Authorised service personnel can set data. Access via USB stick only



Factory pre-setting, no data change possible



Reference to other chapters in the operating instructions



Reference to other documents of the manufacturer

Contents



INFORMATION FOR USERS, QUALIFIED TECHNICIANS AND AUTHORISED SERVICE PERSONNEL

PLEASE READ FIRST.....	2
SYMBOLS.....	2
FUNCTIONING OF THE HEATING AND HEAT PUMP REGULATOR.....	4
INTENDED USE.....	4
EXCLUSION OF LIABILITY.....	4
SAFETY.....	5
CARE OF THE UNIT.....	5
MAINTENANCE OF THE UNIT.....	5
CUSTOMER SERVICE.....	5
WARRANTY / GUARANTEE.....	5
DISPOSAL.....	5



BASIC INFORMATION ON THE OPERATION

THE CONTROL UNIT.....	6
Status Display.....	6
Screen.....	6
"Rotary pushbutton".....	6
Error Messages.....	7
Language of the screen display.....	7
Determining date and time.....	7
Adjusting the contrast of the control element display.....	8
Menu display.....	8
STANDARD SCREEN.....	8
Standard screen "Heating".....	8
Switch to Standard screen "Domestic hot water".....	8
Standard screen "Domestic hot water".....	9
Switch to the Navigation Screen.....	9
The Navigation Screen.....	9
Basic Display.....	9
Display of further program areas.....	9
Special programs display.....	10



PROGRAM AREA "INFORMATION AND QUICK SETTING"

SELECT PROGRAM AREA.....	10
THE MENU "QUICK SETTING: HEATING".....	10
Setting the heating mode of operation.....	11
Setting the time programs of the heating circle.....	11
Same switching times on all days of the week.....	12
Different switching times during the week and on weekends.....	12
Different switching times for each day.....	13

THE MENU "INFO + SETTING DOMESTIC HOT WATER".....	14
Setting the domestic hot water mode of operation.....	14
Setting the domestic hot water temperature.....	14
Setting the domestic hot water off-times.....	15
Care programs.....	15
THE MENU "INFO + SETTING COMPLETE SYSTEM".....	15



PROGRAM AREA "HEATING"

SELECT PROGRAM AREA.....	16
SETTING THE MODE OF OPERATION "HEATING".....	16
TEMPERATURE-SETTING.....	16
Change Temperature.....	17
SETTING THE HEATING CURVE.....	17
Setting the heating curves of the heating circle.....	17
Select table "Heating curve end point".....	18
Determine the heating curve end point.....	18
select the table field Difference temperature (lowered in night mode).....	18
Equalisation of the heating curve end point with the regional standard dimensioning temperature.....	19
Setting the heating curves of mixing circle 1.....	19
Setting a fixed temperature.....	20
Fixed temperature Heating curves.....	20
Fixed temperature Mixing Circle 1.....	20
TIME PROGRAM HEATING.....	21
HEATING LIMIT.....	21



PROGRAM AREA "HOT WATER"

SELECT PROGRAM AREA.....	21
SETTING THE MODE OF OPERATION "DOMESTIC HOT WATER PREPARATION".....	21
SET THE DOMESTIC HOT WATER TEMPERATURE.....	21
Hot water temperature without reheating (factory setting).....	22
Hot water temperature with reheating.....	22
TIME PROGRAMS "DOMESTIC HOT WATER PREPARATION".....	23
High-speed charge.....	23
MAINTENANCE PROGRAMS.....	24
Thermal Disinfection.....	24
Circulation.....	24
Time switches.....	24
Impulse.....	24



PROGRAM AREA "COOLING"

SELECT PROGRAM AREA	25
SETTING THE MODE OF OPERATION "COOLING"	25
SETTING THE COOLING TEMPERATURE	25
SET PARAMETER	26



PROGRAM AREA "PARALLEL CONNECTION"

SELECT PROGRAM AREA	29
IP-ADRESS	29
Set or change the IP address	29
EXTERNAL RETURN FLOW SENSOR	30
SETTING ON THE MASTER HEAT PUMP	30
Search for the heatpump Slaves	30
Status of the master heat pump	30
SETTING THE HEATING	30



PROGRAM AREA "SERVICE"

Calling up short programs	32
Determining priorities	32
DATA LOGGER	32
CONTROL PANEL	33
Web server	33
DHCP Server	33
DHCP Client	33
REMOTE MAINTENANCE	34
Switch on the remote maintenance function	34
Adjust the remote maintenance function	34
Check Connection	34
Manual Data transfer	35
Error causes with connection problems	35
Information on the remote maintenance function	35

Functioning of the heating and heat pump regulator

The heating and heat pump regulator consists of an operating element and an electronic control. This assumes control of the entire heat pump system, the domestic hot water preparation and the heating system. It automatically recognises the connected heat pump type.

The weather-controlled heating curve of the heating system with corresponding lowering and boosting times is set at the heating and heat pump regulator.

The domestic hot water preparation can be carried out via the thermostat (to be set at the customer) or temperature sensor (domestic hot water tank accessories or scope of supply) in accordance with requirements. The domestic hot water preparation via a temperature sensor enables intelligent, adaptive domestic hot water preparation with a high level of comfort.

Low-voltage and 230V signals are effectively isolated by the heating and heat pump regulator. This ensures maximum interference immunity.

Intended use

The unit may be used only for the intended purpose. This means:

- for controlling the heat pump and associated system components.

The unit may be operated only within its technical parameters.

! ATTENTION

The heating and heat pump regulator may only be operated in conjunction with heat pumps approved by the manufacturer and accessories approved by the manufacturer.

Exclusion of liability

The manufacturer will not be liable for damage resulting from unauthorized use of the unit.

The manufacturer's liability will also be voided in the following cases:

- if work is performed on the unit and its components in a manner that does not comply with the terms of this operating manual;
- if work is performed on the unit and its components in an improper manner;
- if work is performed on the unit that is not described in this operating manual, and this work was not expressly approved in writing by the manufacturer;
- if the unit or components in the unit are modified, redesigned or removed without the express written permission of the manufacturer.

Safety

The unit is operationally safe when used for the intended purpose. The construction and design of the unit conform to the state of the art, all relevant DIN/VDE regulations and all relevant safety regulations.

Every person who performs work on the unit must have read and understood the operating manual prior to starting any work. This also applies if the respective person has already worked with such a unit or a similar unit or has been trained by the manufacturer.

Every person who performs work on the unit must comply with the applicable accident prevention and safety regulations. This applies in particular to the wearing of personal safety gear.



DANGER!

Danger of fatal injury due to electric current!
Electrical connections may be installed only by qualified electricians.

Before opening the unit, disconnect the system from the power supply and secure it from being switched back on!



WARNING!

Observe the relevant EN, VDE and/or applicable local safety regulations during the installation and during all electrical work.

Observe the technical connection conditions of the responsible power supply company!



WARNING!

Only qualified technicians (trained heating, cooling, refrigerant and electrical technicians) may perform work on the unit and its components.



ATTENTION

Setting work on the heating and heat pump regulator is only permitted for authorised service personnel and specialist companies who or which have been authorised by the manufacturer.



WARNING!

Observe safety labels in the unit.



ATTENTION

For safety reasons: Do not disconnect the unit from the power supply, unless the unit is being opened.



ATTENTION

Plug X5 and screw terminals X4 of the heating and heat pump regulator are under low voltage. Use only original sensors from the manufacturer (protection class II).



ATTENTION

Circulating pumps may be controlled only by the heating and heat pump regulator. Never shut off circulating pumps externally.



ATTENTION

Never shut off heating circle to the heat pump (frost protection).



ATTENTION

Use only accessories provided by or approved by the manufacturer.

Care of the unit

The outer surfaces of the unit can be cleaned with a damp cloth and household cleaning products.

Do not use cleaning or care products that contain abrasives, acids and/or chlorine. Such products would destroy the surfaces and could also damage the technical components of the unit.

Maintenance of the unit

The heating and heat pump regulator does not require regular maintenance.

Customer service

For technical assistance, contact your qualified technician or the manufacturer's local service partner.



Operating instructions for your heat pump, Appendix, customer service, addresses for service



NOTICE

"T_{Outside min}" and "T_{Outside max}" are not faults that require the customer service to be phoned. The heat pump starts again automatically when the outside temperature lies within the use limits

Warranty / Guarantee

For warranty and guarantee conditions, please refer to the purchase documents.



NOTICE

Please contact your dealer concerning warranties and guarantees.

Disposal

When decommissioning the unit, always comply with applicable laws, directives and standards for the recovery, recycling and disposal of materials and components of cooling units.



Part 2 of the manual of the Heating- and Heatpump Control, chapter "Demontage"



The control unit

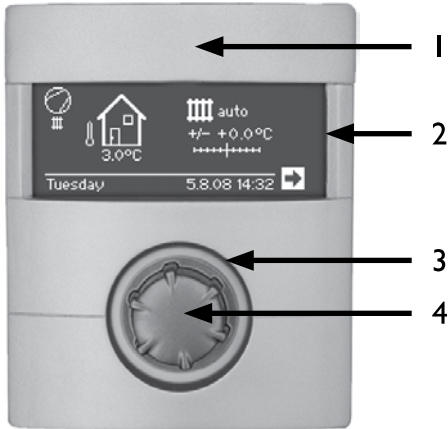

- 1 USB-interface (plug is located behind the flap)
- 2 Screen
- 3 Status display
- 4 "Rotary pushbutton"

STATUS DISPLAY

Ring around the rotary pushbutton lights up **green** = System operating **properly**

Ring around the rotary pushbutton lights up **green/red** = **self-resetting operational interruption**

Ring around the rotary pushbutton lights up **red** = **malfunction**

NOTICE
The display of the control unit has to be accessible and visible any time. Please check regularly the system status from your heatpump.
The unit is configured in the factory to fault mode with ZWE, which means that in the event of a fault and failure of the heat pump, the electrical heating element is activated.

SCREEN

Operating information, functions and setting options for the heating and heat pump regulator and the heat pump system as well as error messages are displayed in the screen of the operating element.

The screen is normally not illuminated. If the "rotary pushbutton" is used, the screen illumination will switch on. It switches off automatically if the "rotary pushbutton" is not pressed after longer than 10 minutes.

Dark background (inverted) = Symbol or menu field is activated

Activating and selecting the navigation arrow will take you from one menu level to the next higher or lower one.

Some menus require the settings you have made to be saved. You can do so through activation and selection of . You can also cancel the settings you have made through activation and selection of .

If a menu has more entries than the screen can display, a scroll bar will appear on the left of the screen. This shows the location you are at in the menu. If no symbol or menu field is selected, you can scroll down the screen display by turning the "rotary pushbutton" to the right. This displays further menu entries. You can scroll back up the screen display again by turning the "rotary pushbutton" to the left.

"ROTARY PUSHBUTTON"

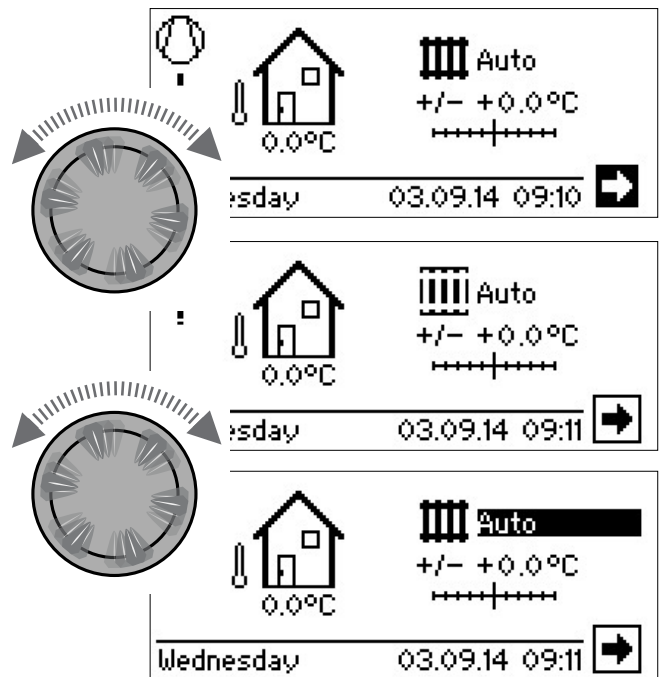

Turn
Activate symbol for a required program level or menu field or scroll down (or up) the screen display.

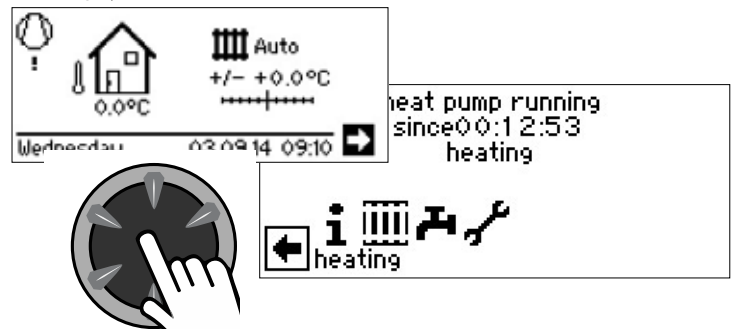

Press (short)
Select **activated symbol** (= change to the corresponding program level) or enable **activated menu field** for entering data and values.

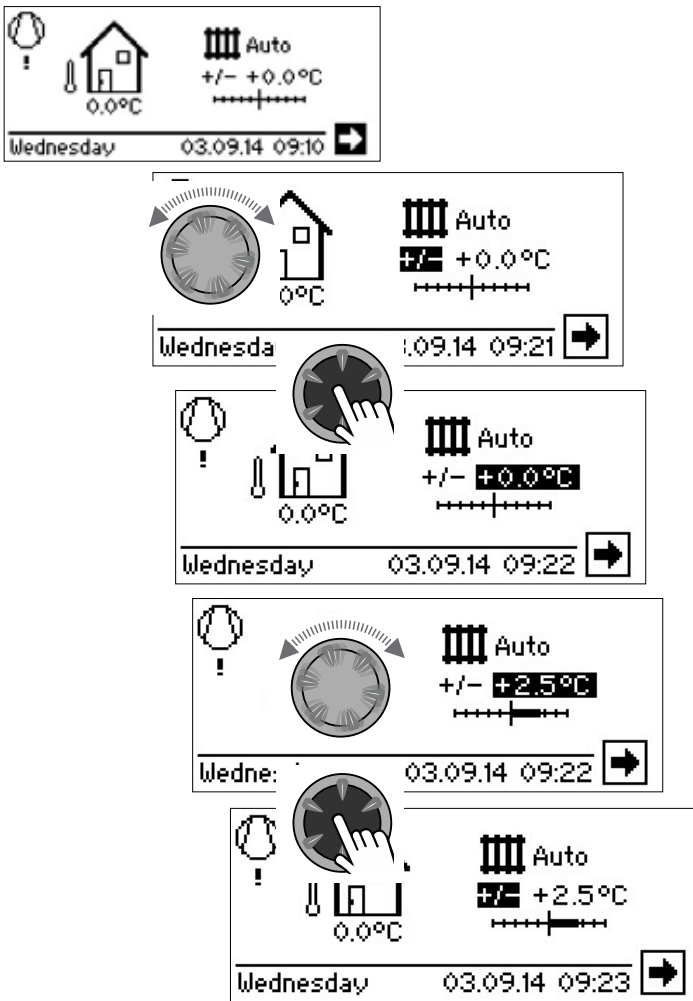

- Turn** Select **activated symbol**
- Press (short)** enable **activated menu field** for entering data and values.
- Turn** Set data and values in the enabled menu field.
- Press (short)** Finish entering data and values in a menu field.

If you keep the "rotary pushbutton pressed for more than 3 seconds, the display will automatically switch back to the navigation screen.

After a further 7 seconds without action, the program will automatically return to the standard screen.

ERROR MESSAGES

If a fault occurs in the system, a corresponding error message will appear in the screen.

! ATTENTION

Before acknowledging a fault, make sure to read the chapters "Error Diagnosis / Error Messages" and "Acknowledging a Fault.."

Part 2 of the manual of the Heating- and Heatpump Control, Overview (Appendix) "Error Diagnosis / Error Messages" and "Acknowledging a Fault."



Press (7 seconds long)

Acknowledge error message and restart the heat pump system (= manual reset).

LANGUAGE OF THE SCREEN DISPLAY

You can specify the language to be used for displaying the menus and texts in the screen.

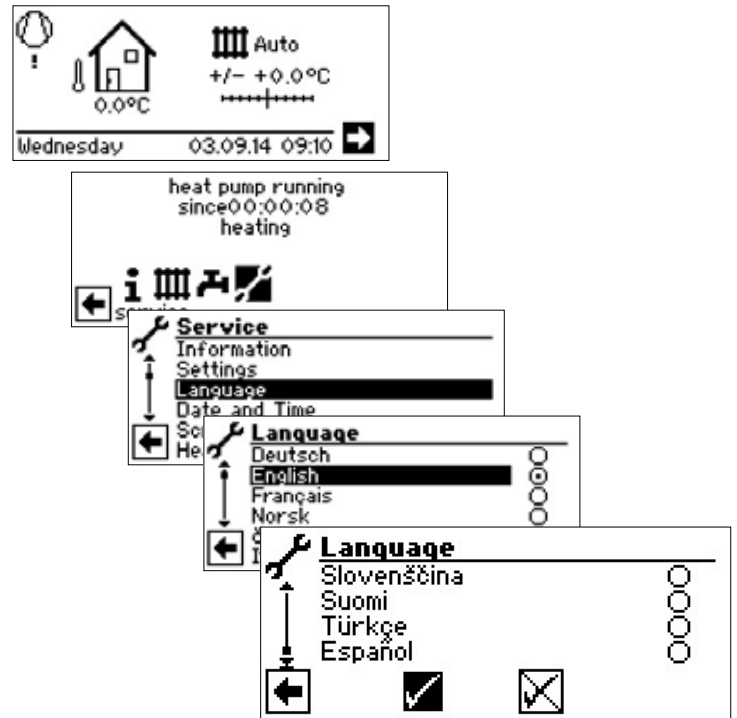

Selecting language of the screen display.

The language selection is also displayed when the heat pump is switched on for the first time.

DETERMINING DATE AND TIME

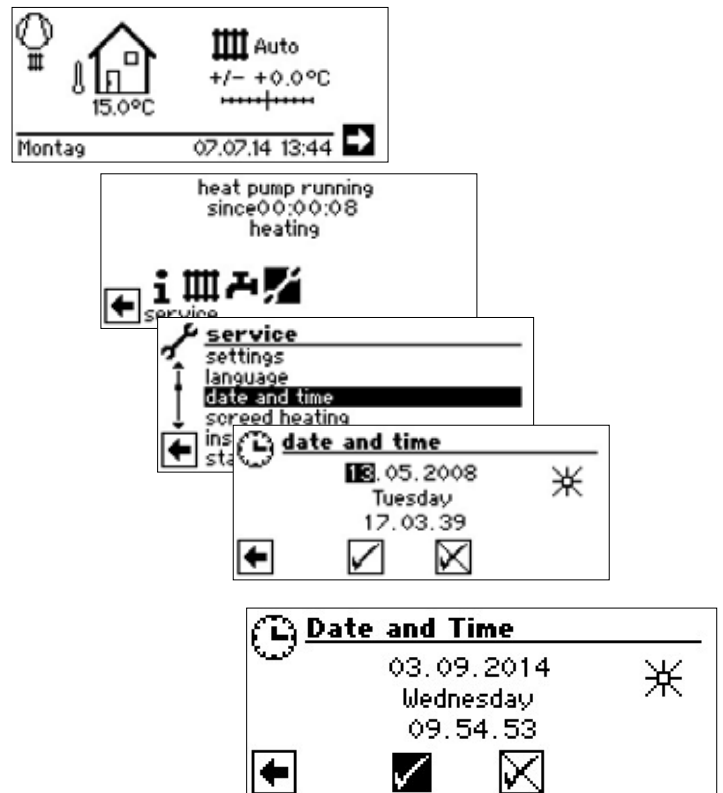



ADJUSTING THE CONTRAST OF THE CONTROL ELEMENT DISPLAY

Adjust the contrast of the control element display to your needs.

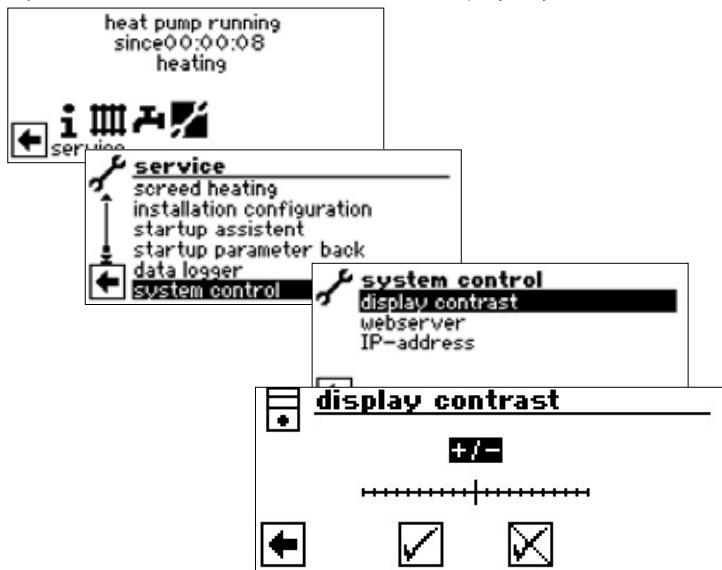

Adjust the contrast by turning the “rotary pushbutton”

MENU DISPLAY

The menu structure is such that menu items that are irrelevant to the system or machine type will be hidden. This means that the display on the regulator may vary from the screens shown in this operating manual.

Standard screen

The standardscreen (= standard-menu) is used for a fast information about the selected mode of operation. Additionally you can set basic settings fast and convenient.

STANDARD SCREEN “HEATING”

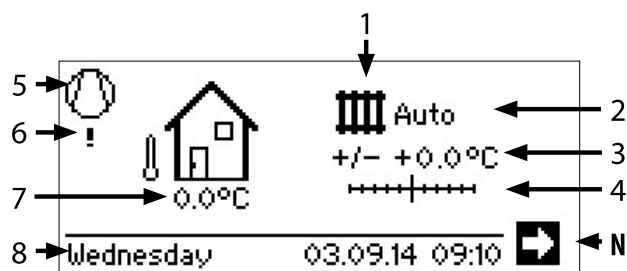

1 Symbol for program area “Heating”

The symbol used for the heating indicates that the adjoining displays and setting options are only relevant to the heating. However, you can press the symbol to switch between the different supply types of the heat pump. This allows you to, for instance, display the symbols used for heating hot water, cooling or swimming pool. The options vary with the heating system you own and the consumers you have connected to it.

2 Current heating mode of operation

Auto, Holidays, 2 hg, Off or Party.

3 Digital temperature display

Shows the extent to which the hot water return flow temperature is to deviate from that of the set heating curve.

Maximum value of the potential deviation: $\pm 5^\circ\text{C}$

4 Temperature scale

Shows in graphical form the extent to which the hot water return flow temperature is to deviate from that of the set heating curve.

Maximum value of the potential deviation: $\pm 5^\circ\text{C}$

5 Compressor

The compressor symbol will turn for as long as the compressor is running.

6 Current operating condition

	Heating
	Hot water
	AScreed heating
	Defrosting
	Electr. suppl.
	Pump flow
	Error
	Cooling

7 Current amb. temp.

8 Date and time

N Navigation arrow

here: Change to the navigation screen

SWITCH TO STANDARD SCREEN “DOMESTIC HOT WATER”

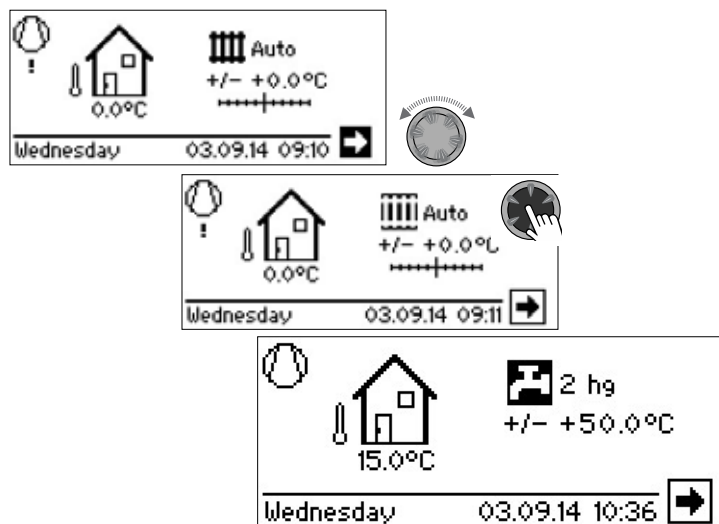

STANDARD SCREEN "DOMESTIC HOT WATER"

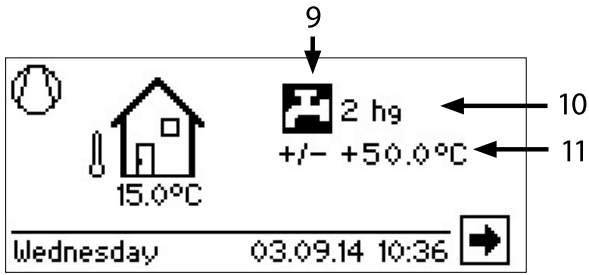

9 Symbol for program area "Domestic Hot Water"

Indicates that domestic hot water functions are being controlled in the standard screen.

10 Current domestic hot water mode of operation

Auto, Holidays, 2 hg, Off or Party.

11 Set temperature for heating hot water

SWITCH TO THE NAVIGATION SCREEN

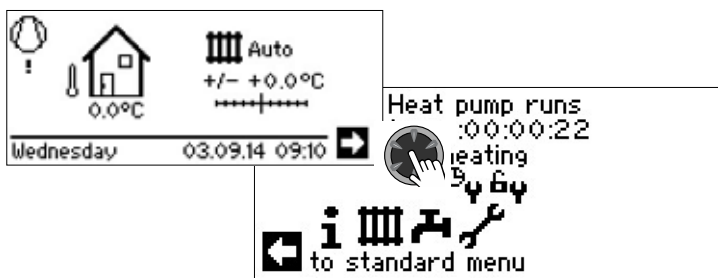

i NOTICE

The navigation arrow is activated automatically in the initial and idle state of the standard screen (silhouetted).

THE NAVIGATION SCREEN

The navigation screen provides an overview of the various program areas of the heating and heat pump regulator.

BASIC DISPLAY



- | | | |
|---|---|-----------------|
| 1 | Current operating state of the heat pump with | time indication |
| 2 | Reason for the current operating state or fault | message |
| 3 | Symbols for the program areas of the heating | and heat pump |
| | regulator | |
| | Standard symbols which are always displayed | are: |
| 4 | Information on the activated symbol. | |

Standard symbols which are always displayed are:

- Symbol for program area "Information and Quick Setting"
Operating information and system operation by the user
Enabled for all users
- Symbol for program area "Heating"
Program area for setting all parameters for the heating and mixing circle
Only for qualified technicians
- Symbol for program area "Domestic Hot Water"
Program area for setting all parameters for domestic hot water preparation
Only for qualified technicians
- Symbol for program area "Service"
Program area for setting the basic system parameters
Only for authorised service personnel
In parts, access via USB stick only
- Symbol for program area "Parallel Connection Master"
Connection of up to 4 heat pumps with one another.
Only for qualified technicians.
- Symbol for program area "Parallel Connection Slave."
Only for qualified technicians.

DISPLAY OF FURTHER PROGRAM AREAS

Depending on the type of heat pump connected, the navigation screen can display the following program area symbols:

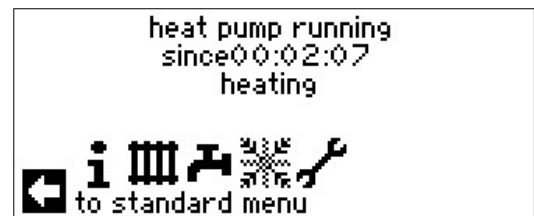

- Symbol for program area "Cooling"

for the conditions underlying display of the symbol:
page 25, Program area "Cooling"

i NOTICE

Depending on your system and the configuration of the heating and heat pump regulator, further program area symbols can be shown in the screen.



SPECIAL PROGRAMS DISPLAY

If special programs are active, their symbols will be displayed in the navigation screen.

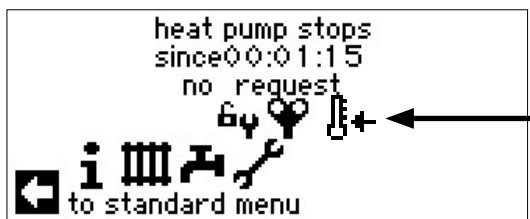

- Ventilation program
- Customer service or fitter access
- Screed heating program
- Short program
- Forced heating
- Forced domestic hot water
- Forced defrosting
- USB-stick is plugged in
- Cold start (interrupt)

Air-water heat pumps are equipped with a cold start function.

The function is activated if, when outside temperature reach $< 10^{\circ}\text{C}$, the return temperature falls below 15°C . At that point, the AHG will be activated until the return temperature exceeds 15°C . Only then will the heat pump be enabled again.

Cold start is terminated at a return temperature of 23°C .

It is possible to interrupt the cold start by pressing the symbol . The cold start will then remain deactivated until the next time the regulator is started.

NOTICE

If you select and activate the symbol of a special program, you will be taken directly to the relevant special program.

The displays described on the following pages allow / require you to make a selection. In general:

– you can **only** select **one** option in circular fields:

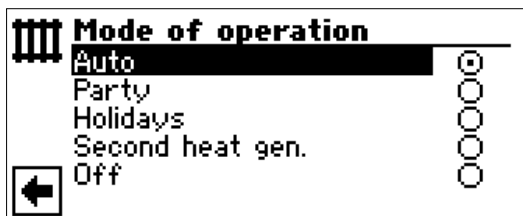

– you can “click” boxes multiple times:

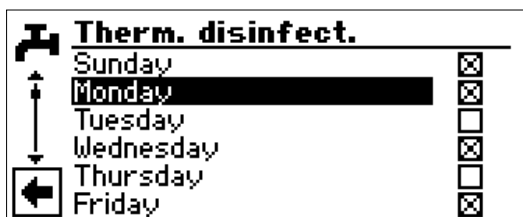

Program area “Information and Quick Setting”

SELECT PROGRAM AREA

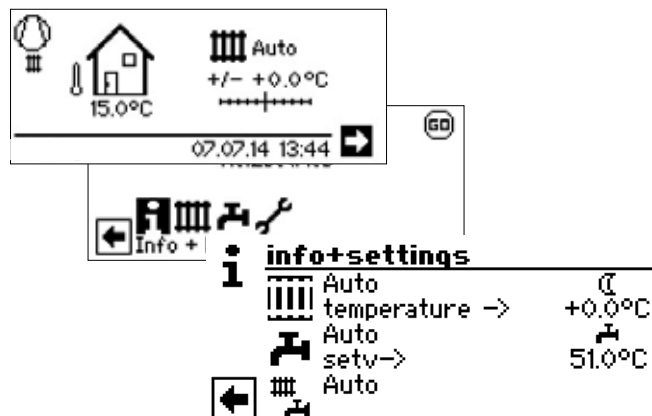

THE MENU “QUICK SETTING: HEATING”

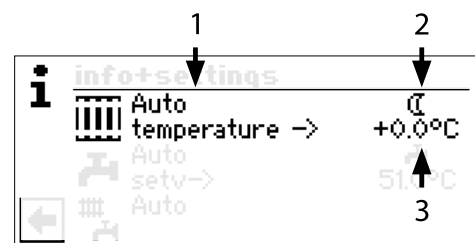

1 Menu field “Current mode of operation”

Possible displays:

- Automatic
- Party (= Continuous daytime operation)
- Holidays
- 2 hg (=Second heat generator)
- Off

2 Menu field “Heating time prog”

Shows whether the heat pump is operating in day or night mode:

- Symbol for day mode: Heating is raised
- Symbol for night mode: Heating is lowered

3 Menu field “Temperature deviation”

Shows the extent to which the currently required hot water return flow temperature deviates from that of the set heating curve.

SETTING THE HEATING MODE OF OPERATION

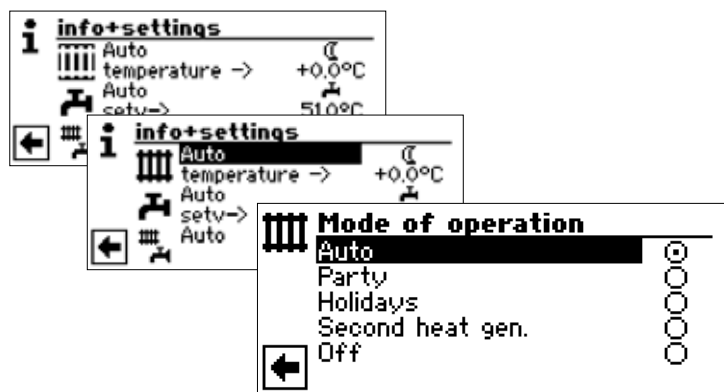

The current mode of operation is highlighted with :

Auto

Heating circle works according to programmed time programs.

Party

Continuous heating boost. The settings for night mode are switched off *straightaway for the duration of 24 hours or until another mode of operation is selected.*

Holidays

Continuous heating reduction. The settings for day mode are switched off *straightaway until the set date is reached or until another mode of operation is selected.*

If the "Holidays" mode of operation is selected, the screen changes to the menu "End of holidays"

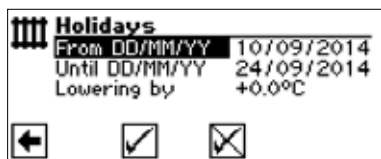

From DD/MM/YYYY

Begin of holidays: Set day / month / year

Until DDD/MM/YYYY

End of holidays: Set day / month / year

lowering by

Set lowering

2nd heat gen. Second heat generator

The programmed time programs control the heating, *without* switching on the heat pump.

Off

The heating is switched off (= summer mode), the antifreeze function is switched on (return setpoint = 15 °C; the heat pump starts operating if the return setpoint is fallen below)

For air / water heat pumps and an outdoor air temperature of less than 10°C, the value switches to 20°C return setpoint

NOTICE

This menu performs the same function as the "Quickly changing the hot water return flow temperature" in the standard screen.

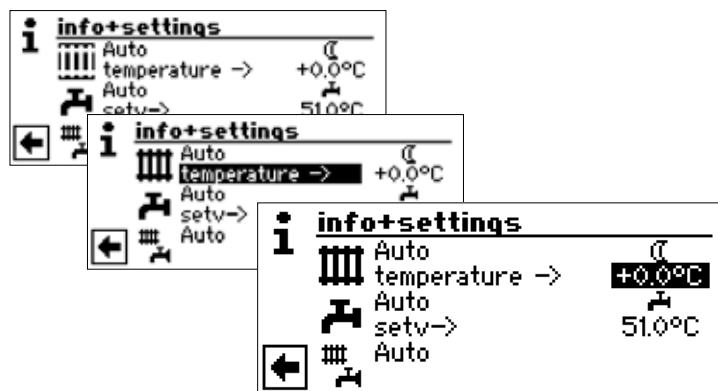

Temperature

Change hot water return flow temperature of the set heating curve by the required temperature (value range: ± 5 °C):

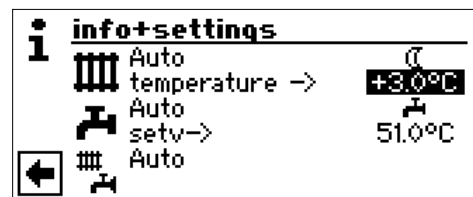

Finish entry by pressing the "rotary pushbutton". This saves the required temperature. The program automatically activates the symbol .

SETTING THE TIME PROGRAMS OF THE HEATING CIRCLE

NOTICE

You can only select and activate the "Heating time prog" – * or – if the mode of operation "Auto(matic)" is active.

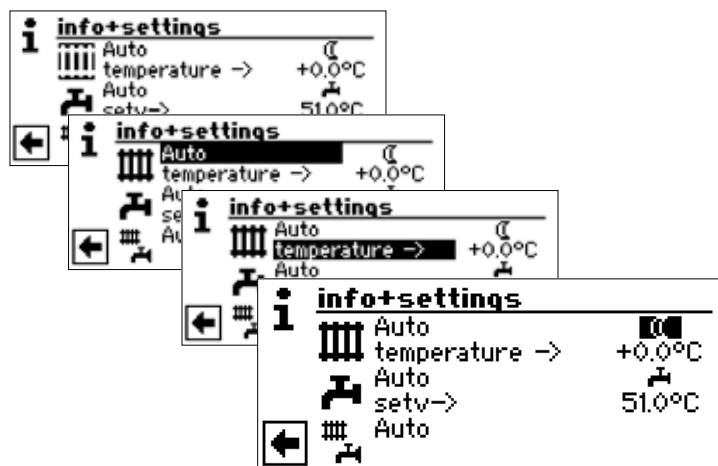

If you select the menu field "Settings", the screen will change either to the menu "Time programs" or directly to the menu "Heating circle" (depending on the system setting made by the authorised service technician):

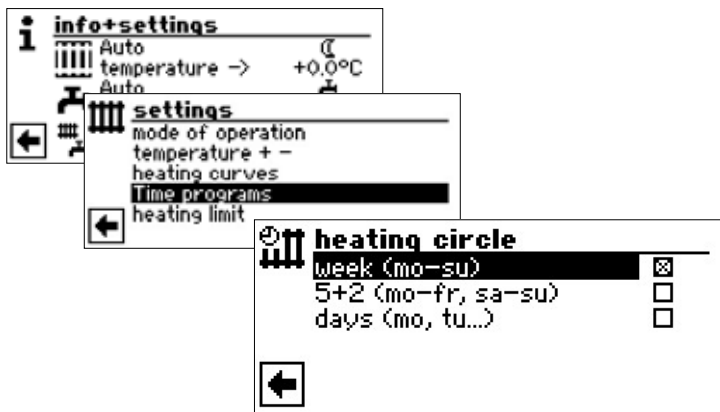

Week (Mo – Su)

Same times for all days of the week

5 + 2 (Mo – Fr, Sa – Su)

Different times during the week and on weekends

Days (Mo, Tu,...)

Different times for each day

NOTICE

The time programs are programmed in the menus “All” and “Mixing circ 1” in the same way as the example described below “Heating circ”.

SAME SWITCHING TIMES ON ALL DAYS OF THE WEEK

You can specify a maximum of three times periods within 24 hours at which the heating is to be raised. The specified time periods apply for every day of the week.

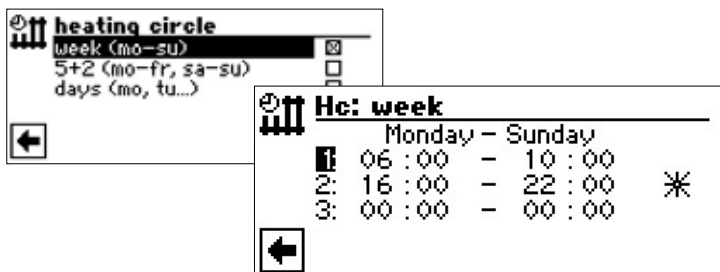

Monday – Sunday

The displayed time programs apply for every day of the week. The heating is raised within the time period indicated (= day mode). The heating is also lowered at the remaining times (= night mode).

- 1:** Switching channel 1 with typical time period. In the example shown, the heating is increased daily from 06:00 – 10:00 hours.
- 2:** Switching channel 2 with typical time period. In the example shown, the heating is increased daily from 16:00 – 22:00 hours.
- 3:** Switching channel 3 with typical time period. Not specified in the example shown.

✳ Symbol for “Day mode”

Indicates that the heating works in day mode at the specified time periods, i.e. it is increased.

NOTICE

With a time period of 00:00 – 00:00 the heating is generally lowered. It only works in night mode.

Scroll down the menu. Settings made are saved by activating and selecting or cancelled by activating and selecting .

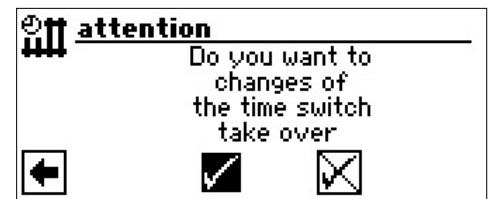

NOTICE

If the settings have been saved, the time settings “Hc: Week” overwrite existing time settings in “Hc: 5+2” and “Hc: Days”. At the same time, the switching time control “Week (Mo – Su)” is switched on and automatically marked by in the time programs submenu “Heating circle”.

DIFFERENT SWITCHING TIMES DURING THE WEEK AND ON WEEKENDS

You can specify a maximum of three time periods at which the heating circle is to be raised for both day groups Monday – Friday and Saturday – Sunday (= Weekend).

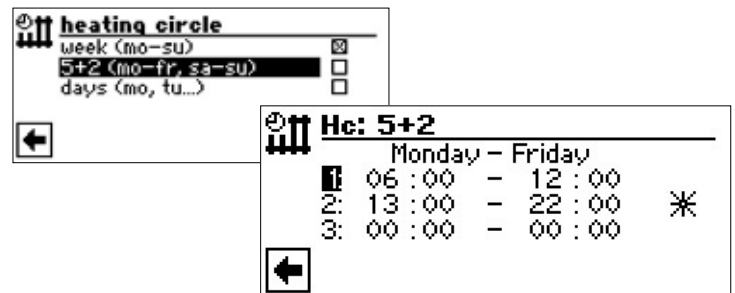

Monday – Friday

The displayed time programs apply for every day of the week. The heating is raised within the time period indicated (= day mode). The heating is also lowered at the remaining times (= night mode).

- 1:** Switching channel 1 with typical time period. In the example shown, the heating is increased daily from 06:00 – 12:00 hours.
- 2:** Switching channel 2 with typical time period. In the example shown, the heating is increased daily from 13:00 – 22:00: hours.
- 3:** Switching channel 3 with typical time period. Not specified in the example shown.

✳ Symbol for “Day mode”

Indicates that the heating works in day mode at the specified time periods, i.e. it is increased.

NOTICE

With a time period of 00:00 – 00:00 the heating is generally lowered. It only works in night mode.

Scroll down the menu:

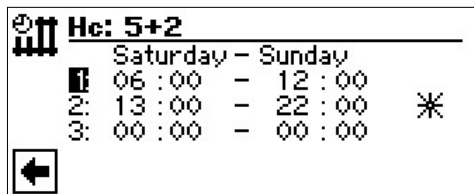

Saturday – Sunday

The displayed time programs apply for every day of the week. The heating is raised within the time period indicated (= day mode). The heating is also lowered at the remaining times (= night mode).

- 1:** Switching channel 1 with typical time period. In the example shown, the heating is increased daily from 06:00 – 12:00 hours.
- 2:** Switching channel 2 with typical time period. In the example shown, the heating is increased daily from 16:00 – 22:00 hours.
- 3:** Switching channel 3 with typical time period. Not specified in the example shown.

✱ Symbol for "Day mode"

Indicates that the heating works in day mode at the specified time periods, i.e. it is increased.

NOTICE

With a time period of 00:00 – 00:00 the heating is generally lowered. It only works in night mode.

Scroll down the menu. Settings made are saved by activating and selecting or cancelled by activating and selecting .

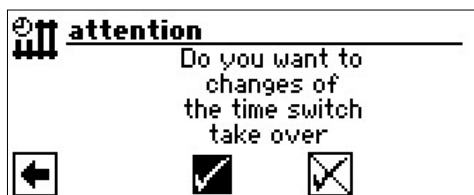

DIFFERENT SWITCHING TIMES FOR EACH DAY

NOTICE

If time programs have been programmed in the time programs "Week (Mo – Su)" or "5 + 2 (Mo – Fr, Sa – Su)" and you wish to diverge from this on (a) certain day(s), you can program the program times for this/these day(s) here correspondingly

You can specify a maximum of three time periods for each day at which the heating is to be raised.

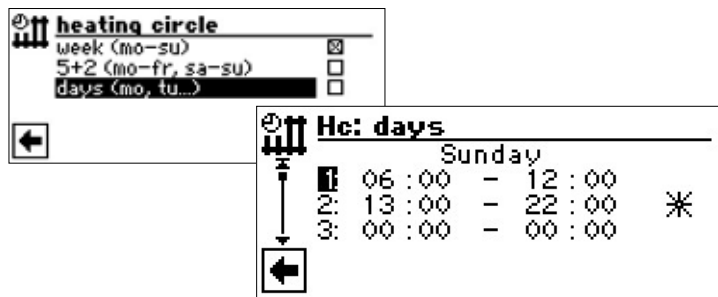

Sunday

The displayed time programs apply for every day of the week. The heating is raised within the time period indicated (= day mode). The heating is also lowered at the remaining times (= night mode).

- 1:** Switching channel 1 with typical time period. In the example shown, the heating is increased daily from 06:00 – 12:00 hours.
- 2:** Switching channel 2 with typical time period. In the example shown, the heating is increased daily from 13:00 – 22:00 hours.
- 3:** Switching channel 3 with typical time period. Not specified in the example shown.

✱ Symbol for "Day mode"

Indicates that the heating works in day mode at the specified time periods, i.e. it is increased.

NOTICE

With a time period of 00:00 – 00:00 the heating is generally lowered. It only works in night mode.

The menus for other days (Monday, Tuesday ...) are called up by scrolling through the screen.

Scroll down the menu. Settings made are saved by activating and selecting or cancelled by activating and selecting .

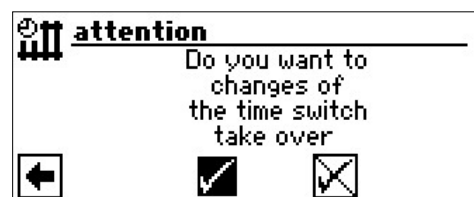

THE MENU "INFO + SETTING DOMESTIC HOT WATER"

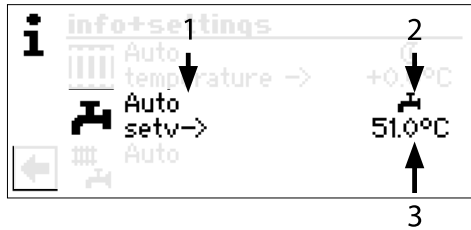

1 Menu field "Current mode of operation"

Possible displays:

- Auto
- Party (=Continuous daytime operation)
- Holidays
- 2 hg (=Second heat generator)
- Off

2 Menu field "Off-times"

Displays the status of the domestic hot water preparation::

- Domestic hot water preparation enabled
- Domestic hot water preparation stop

3 Menu field "Hot wasser temperature".

Displays the required domestic hot water temperature (= setpoint value)

NOTICE

Whether the menu field "Domestic hot water" and menu line title "Setpoint domestic hot water temperature" are displayed depends on the system setting.

SETTING THE DOMESTIC HOT WATER MODE OF OPERATION

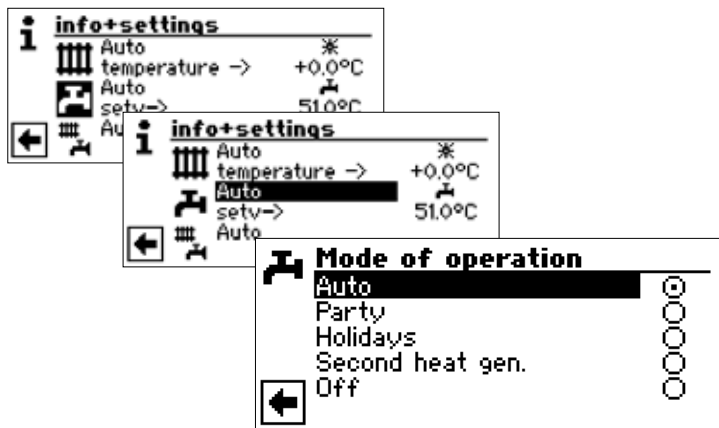

The current mode of operation is highlighted with :

Automatic

Domestic hot water preparation is *stopped* after the programmed program times.

Party

The domestic hot water preparation works in continuous mode *straightaway for the duration of 24 hours until another mode of operation is selected.*

Holidays

The domestic hot water preparation is stopped *straightaway until the set date is reached or until another mode of operation is selected.*

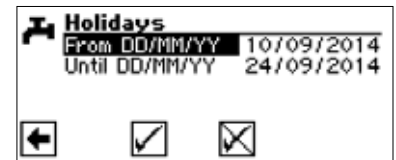

From DD/MM/YYYY

begin of holidays: set day / month /year

Until DD/MM/YYYY

end of holidays: set day / month /year

2nd heat gen

The programmed program times control the domestic hot water preparation, *without* selecting the heat pump

Off

Domestic hot water preparation is switched off.

SETTING THE DOMESTIC HOT WATER TEMPERATURE

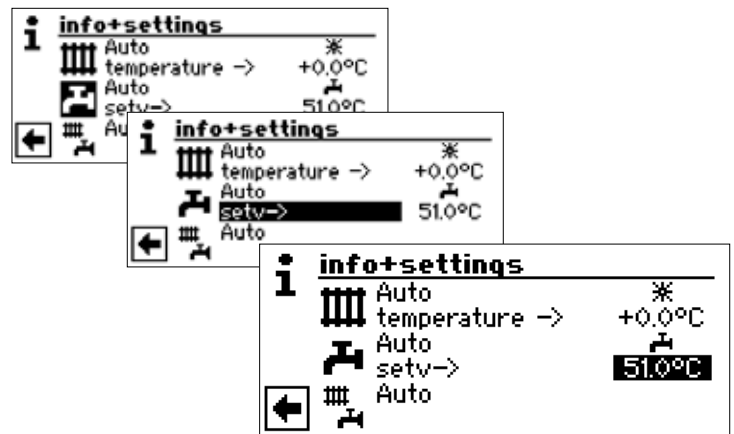

Set the required domestic hot water temperature (= setpoint value): 30 °C.

Terminate input. This saves the required temperature.

NOTICE

In conjunction with domestic hot water tanks recommended by the manufacturer, your heat pump can generate domestic hot water temperatures which are around 7 K lower than the maximum flow temperature of your heat pump.

NOTICE

If a domestic hot water temperature is set which cannot be attained, the heat pump will initially switch to "Error high pressure". This is followed by a self-resetting fault (If heating is required, this will also be operated). After 2 hours have passed, the domestic hot water preparation starts again. Nevertheless, the program of the heating and heat pump regulator automatically lowers the setpoint value for this by an initial 1 °C. If this setpoint temperature cannot be attained either, the process is repeated until a temperature can be attained.

The set desired value remains unaffected and is displayed unchanged.

SETTING THE DOMESTIC HOT WATER OFF-TIMES

You can only select and activate the “Off-times” – or – if the “Automatic” mode of operation is active.

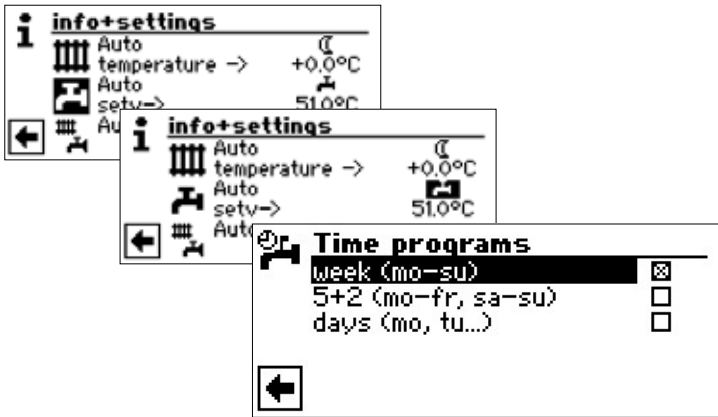

The time programs for the domestic hot water are programmed as described in chapter “Setting the time programs of the heating circle” (page 11).

NOTICE

When programming, ensure that the time periods which you specify in the area “Time programs domestic hot water preparation” are **off times**. The domestic hot water preparation is switched off in the time periods entered.

If you require domestic hot water despite active off-time(s), you can select a domestic hot water preparation and then terminate it again via the function “High-speed charge” by bypassing the programmed off-time(s).

page 23, “High-speed charge”

CARE PROGRAMS

page 24, “Thermal disinfection” and “Cirkulation”

THE MENU “INFO + SETTING COMPLETE SYSTEM”



1 Menu field “current mode of operation”

Possible displays:

Auto

Party (=Continuous daytime operation)

Holidays

Off

A dotted line means that the individual areas of the system work in different modes of operation.

Proceed as follows if you wish to specify a common mode of operation for the individual areas of your system:

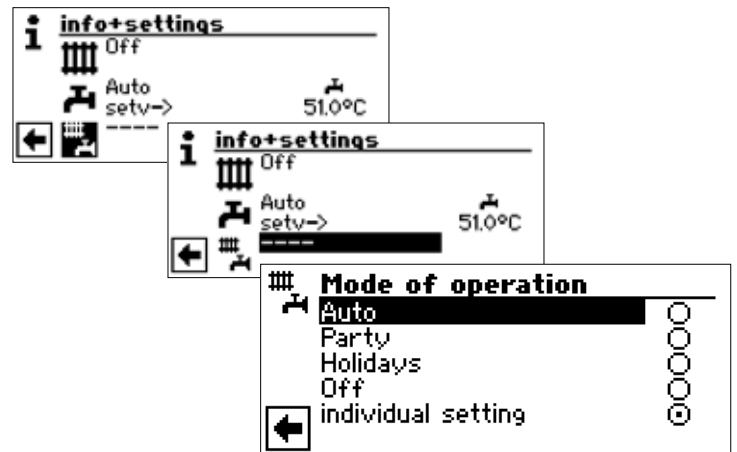

The current mode of operation is highlighted with .

You can now choose which mode of operation is to apply for all areas of your system. At the same time, the mode of operation “Holidays” requires a “Program end” to be programmed..

page 11, “Setting the heating mode of operation”, “Holidays”

The mode of operation you select in the menu “Complete system” is automatically assigned to all individual areas of your system.

An example:

You wish to set the heating and domestic hot water preparation to continuous day mode for a short time owing to a party in your house. After the party, all areas of your system are to operate in automatic mode.

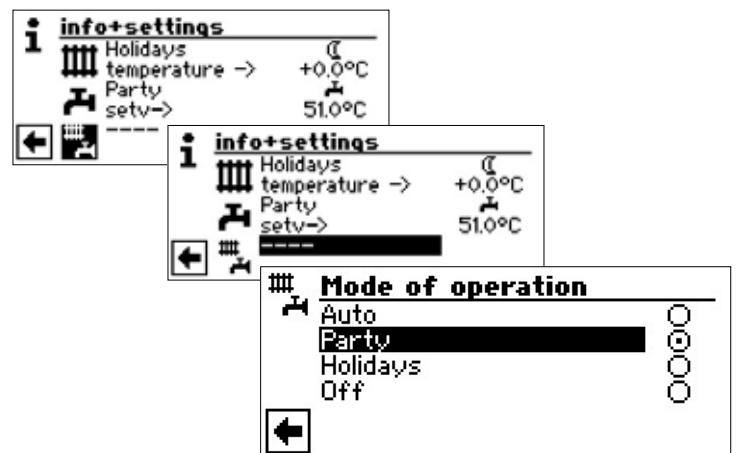

Party

All areas of your system are automatically switched over to continuous day mode.

After the party has finished, select and activate the “Complete system” menu, then select and activate the menu field “Automatic” in the “Mode of operation” menu:

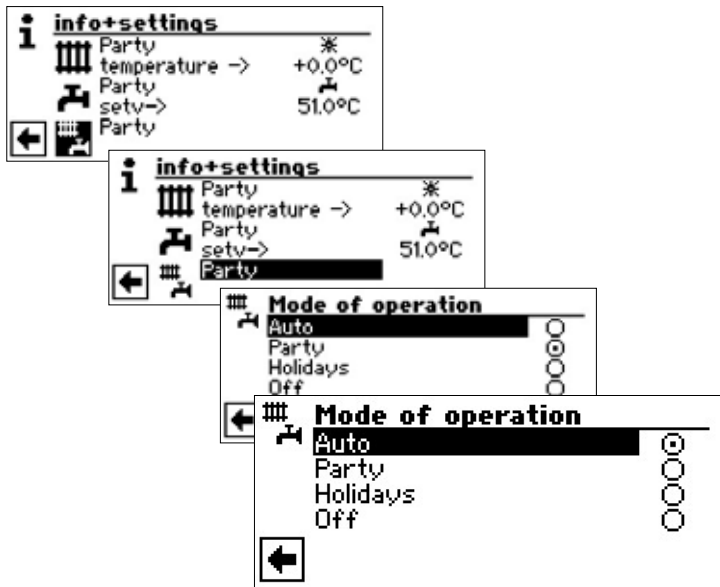

Automatik

All areas of your system are switched over to the "Automatic" mode of operation and work as specified by the set time.

NOTICE

If you want the individual areas of your system to work in different modes of operation (for example heating "Off", domestic hot water preparation "Automatic"), you have to select the menu field "Indiv. setting" (= individual setting). You can then see the required mode of operation via the menu of the relevant program area of your system (heating, domestic hot water, ...).

page 11, "Setting the heating mode of operation" and page 14, "Setting the domestic hot water mode of operation"

Program area "Heating"

SELECT PROGRAM AREA

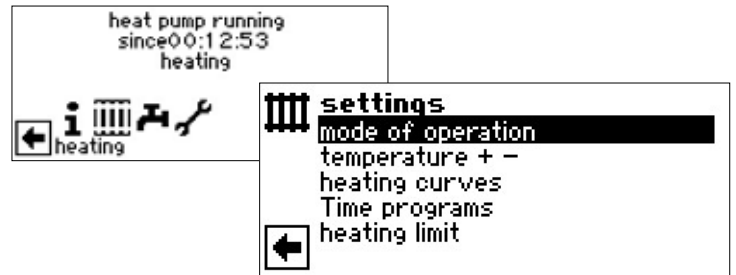

Menu field "Operating Mode"

takes you to the menu "Heating Operating Mode"

Menu field "Temperature + -"

takes you to the menu "Heating Temperature-Finetuning"

Menu field "Heating Curves"

takes you to the menu "Heating curves"

Menu field "Timer program"

takes you to the menu "Heating Time programs"

Menu field "Heating limit"

takes you to the menu "Heating limit"

SETTING THE MODE OF OPERATION "HEATING"

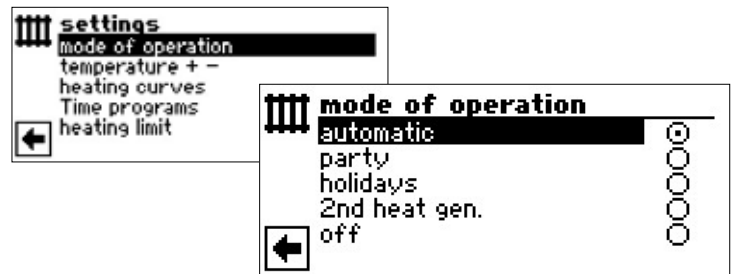

The current mode of operation is highlighted with

page 11, "Setting the heating mode of operation"

TEMPERATURE-SETTING

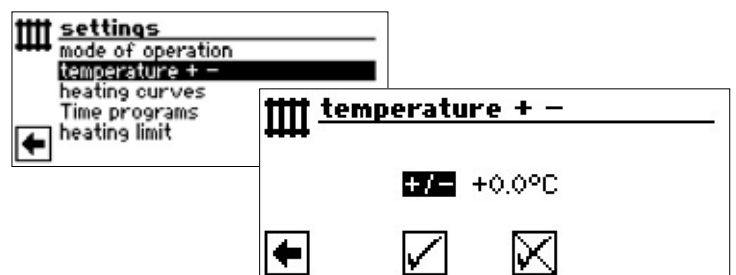

Menu field "Temperature deviation"

Entries are displayed in 0.5 °C increments.

Reference variable: Set heating curve

NOTICE

This menu allows you to carry out the fine setting of the heating curves. If temperature changes are saved, this is accepted auto-adaptively into the heating curves.

This means:

On the basis of the changes in the menu "Temperature + -", the program of the heating and heat pump regulator calculates the base and end point of the heating curves in relation to the external temperature and offsets it

CHANGE TEMPERATURE

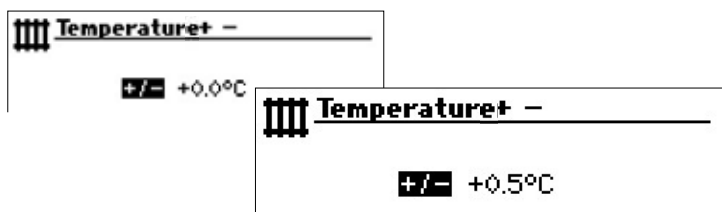

Entries are displayed in 0.5 °C increments.

Reference variable: Set heating curve

Increase temperature:

Activate and select menu field "Warmer". The hot water return flow temperature is increased by 0.5 °C with every turn.

Lower temperature:

Activate and select menu field "Colder". The hot water return flow temperature is lowered by 0.5 °C with every turn.



NOTICE

First only change the temperature by 0.5 °C. Wait 2 to 3 days before changing again and check how the room temperature has developed.

NOTICE

When saved, the heating curves are automatically changed by the temperature values entered. The values in the menu fields "Temperature scale" and "Temperature deviation" are set to zero after saving in the menu "Temperature + -".

Once you have saved your settings, the program provides a corresponding feed back in the screen.

SETTING THE HEATING CURVE

The hot water temperatures of heating systems calculated in relation to the external temperature are designated as heating curve. Within specified limit values, the hot water temperatures rise (fall) if the external temperature falls (rises).

NOTICE

The settings for the heating circle control how the heat pump is switched on and off depending on the temperature.

SETTING THE HEATING CURVES OF THE HEATING CIRCLE

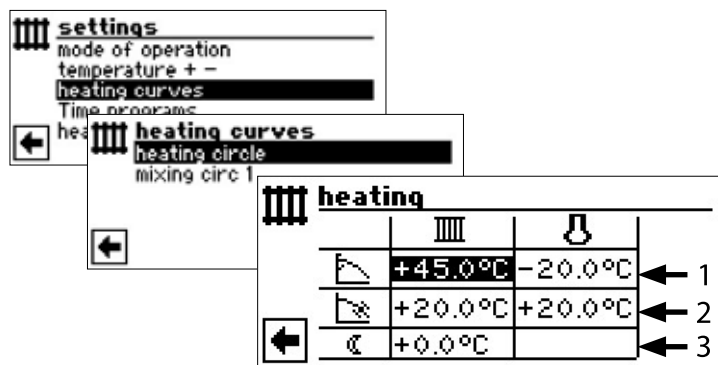

NOTICE

If the menu "Heating curves" appears, select the menu field "Heating circle". The heating curves for the heating circle can be programmed if no fixed temperature is set.

☞ page 20, "Setting a fixed temperature"

III Return flow temperature of heating circle

⌚ Reference value for external temperature

1 Table line "Heating curve end point"

↘ Symbol for "Heating curve end point"
45 °C Table field "Heating curve end point"
Example value here: 45 °C

-20 °C Table field "Reference value for external temperature" (= program setting that cannot be changed)
The example shows means that the hot water return flow temperature is to be 45 °C at an external temperature of -20 °C.

2 Table line "Parallel offset"

↘ Symbol for "Parallel offset"
20 °C Table field "Parallel offset".
Example value here: 20 °C (neutral)

20 °C Table field "Reference value for external temperature"
20 The example shown indicates that the base of the heating curve is to be 20 °C at an external temperature of 20 °C.

An increase in the temperature value in the table field "Parallel offset" to, for example, 22 °C causes a parallel offset of the heating curve by 2 °C upwards, while a reduction to, for example, 18 °C causes a parallel offset of the heating curve by 2 °C downwards.

3 Table line "Night reduction"

⌚ Symbol for night mode: Heating is lowered



-5 °C Table field "Difference temperature"
The example shown indicates that the heating in night mode is lowered by 5 °C in comparison to day mode.

SELECT TABLE "HEATING CURVE END POINT"

heating		
	III	U
△	+45.0°C	-20.0°C
▽	+20.0°C	+20.0°C
⊞	+0.0°C	

Set the return flow temperature value in the table field "Heating curve end point".

i NOTICE

The heating curve end point always refers to an external temperature of -20 °C. If the heat pump is used in a climatic zone in which the external temperature value of -20 °C is not reached, you need to equalise the heating curve end point with the regional standard design temperature..

page 19, "Equalisation of the heating curve end point with the regional standard dimensioning temperature"

i NOTICE

The temperature values refer to the return flow. You need to subtract the spread for flow temperatures.

Example diagram:

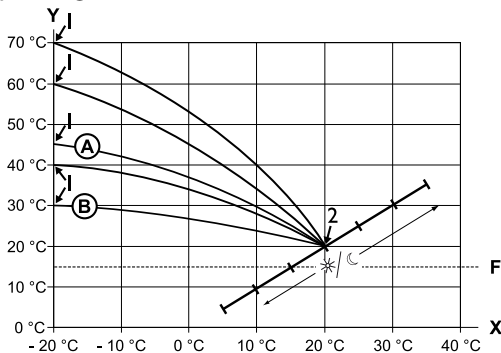

- X External temperature
- Y Return temperature
- 1 Heating curve end point
- 2 Heating curve base
- F Antifreeze
- Ⓐ Heating curve with heating curve end point of 45 °C return temperature (for example when using radiators)
- Ⓑ Heating curve with heating curve end point of 30 °C return temperature (for example when using floor heating) respectively at -20 °C external temperature as well as heating curve base of 20 °C return temperature at +20 °C external temperature.

Set further parameters or scroll down to the bottom of the screen and continue with page 19, "Equalisation of the heating curve end point with the regional standard dimensioning temperature"

DETERMINE THE HEATING CURVE END POINT

heating		
	III	U
△	+45.0°C	-20.0°C
▽	+20.0°C	+20.0°C
⊞	+0.0°C	

heating		
	III	U
△	+45.0°C	-20.0°C
▽	+30.0°C	+30.0°C
⊞	+0.0°C	

Set return temperature value.

Set return temperature value. A turn to the right results in a parallel offset of the heating curve by 0.5 °C upwards. A turn to the left results in a parallel offset of the heating curve by 0,5 °C downwards.

i NOTICE

The parallel offset has an effect on the day and night mode.

Example diagram:

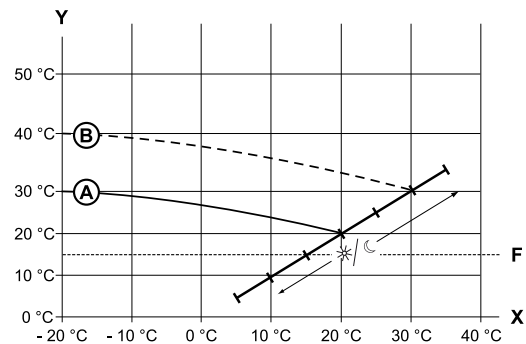

- X External temperature
- Y Return temperature
- F Antifreeze
- Ⓐ Heating curve with heating curve end point at 30 °C return temperature and heating curve base at 20 °C return temperature
- Ⓑ Heating curve after parallel offset moved by 10 °C upward.

③ Finish entry in the table field "Parallel offset".

Set further parameters or scroll down to the bottom of the screen and continue with page 19, "Equalisation of the heating curve end point with the regional standard dimensioning temperature"

SELECT THE TABLE FIELD DIFFERENCE TEMPERATURE (LOWERED IN NIGHT MODE)

heating		
	III	U
△	+45.0°C	-20.0°C
▽	+20.0°C	+20.0°C
⊞	+0.0°C	

heating		
	III	U
△	+45.0°C	-20.0°C
▽	+20.0°C	+20.0°C
⊞	-5.0°C	

Example diagram:

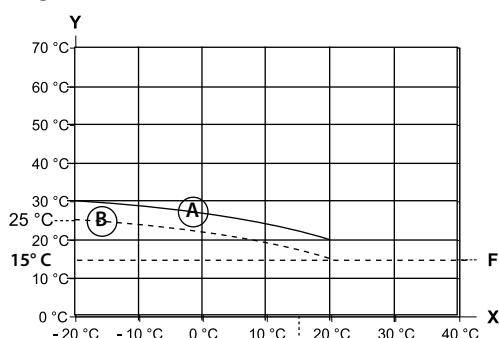

- X External temperature
- Y "Return temperature"
- F Antifreeze
- Ⓐ Heating curve in daytime mode
- Ⓑ Heating curve offset parallel by -5 °C in night mode

Viewed over the entire range, the heating curve in night mode is 5 °C below the heating curve in day mode.

NOTICE

If your system works in the mode of operation "Auto(matic)", it will automatically switch over between daytime (raise) and night-time mode (lower).

EQUALISATION OF THE HEATING CURVE END POINT WITH THE REGIONAL STANDARD DIMENSIONING TEMPERATURE

NOTICE

Required only if the heating curve is to be compensated to regional standard design temperature.

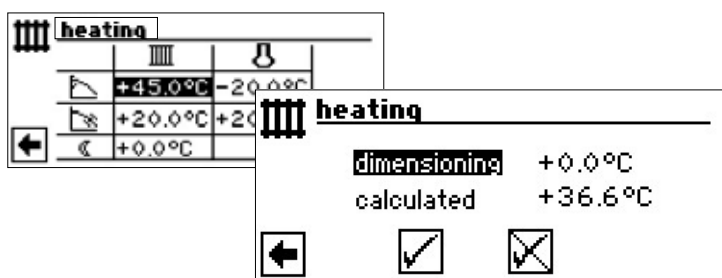

Menu line "dimensioning" regional standard design temperature
 Menu line "calculated" Calculated temperature heating curve end point" for regional standard dimensioning temperature

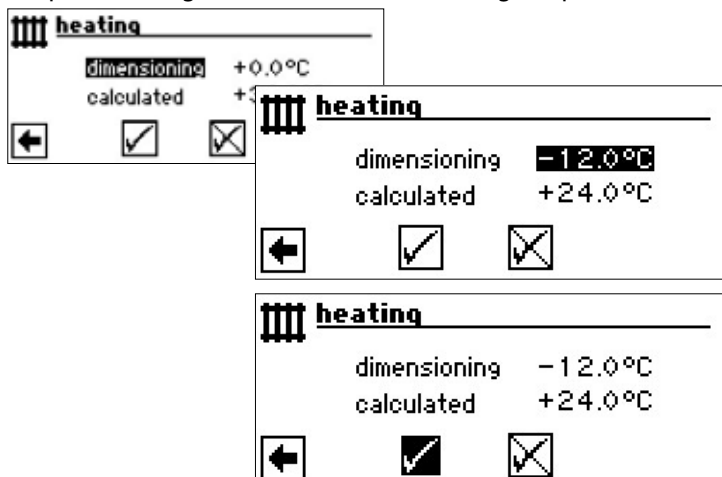

The program of the heating and heat pump regulator now calculates the actual return temperature at -12 °C for the heating curve end point and displays this in the menu field "Calculated". In the example +24,0 °C:

If the calculated return temperature corresponds to the return temperature you require, you can quit the menu.

If, however, the system operates to another return temperature, select and activate the table field "Heating curve end point" in the table line "Heating curve end point", and change the return temperature value upwards or downwards (depending on whether a higher or lower value is required).

Now check the temperature value displayed after the menu field "Calculated".

If the calculated value now corresponds to the return temperature you require, you can quit the menu.

Otherwise scroll all the way up the menu "Heating curve Heating" and repeat steps until the calculated value comes closest to the required return temperature.

NOTICE

An exact correspondence of the calculated value with the required return temperature is hardly possible, as you can only set the return temperature value in 0.5 °C- increments in the "Heating curve end point" menu field. Accept a return temperature which is as close as possible to what you are aiming for.

NOTICE

Adjusting the heating curve to reasonable settings is crucial for the heat pump to operate in the most energy efficient way. Setting the heating curve too high will increase the total energy consumption of the system!

NOTICE

The settings for the heating circle control how the heat pump is switched on and off depending on the temperature.

SETTING THE HEATING CURVES OF MIXING CIRCLE 1

1

NOTICE

Menu access to the heating curves of mixing circle 1 is only possible if a mixer is installed in the system and mixing circle 1 is defined as a discharge mixing circle in the system setting.





The screen changes to the menu "Heating curves Mixing circle 1". The heating curves can be programmed if no fixed temperature is defined.

page 20, "Setting a fixed temperature"

Follow the instructions on page 11, "Setting the heating mode of operation"

NOTICE
Ensure that you always define flow temperatures when setting the heating curves of mixing circle 1.

SETTING A FIXED TEMPERATURE

NOTICE
You can only determine a fixed temperature if this option has been selected by the system setting.

Part 2 of the controller manual, program area "Service", chapter "Determining system settings", "Setting hc" und "Setting mc1".

NOTICE
The fixed temperature is heated to independently of the external temperature.

NOTICE
If a night reduction is required in the "Fixed temperature" mode, the difference temperature must be set in the heating curves "Heating" or "Mixing circle 1", before the option "Fixed temperature" is selected.

If no night reduction is required, the difference temperature must be set to 0 °C in the heating curves "Heating" or "Mixing circle 1" (= factory setting).

FIXED TEMPERATURE HEATING CURVES

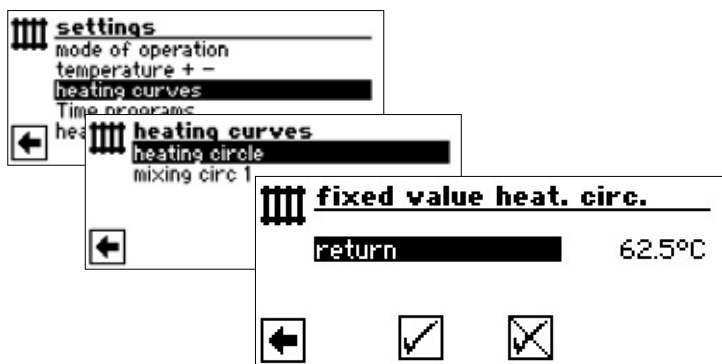

If the option "Fixed temperature" is switched on by the system setting, the screen changes to the menu "Heating curves" (which can take you to the menus "Fixed value heating circle" or "Fixed value mixing circle") or directly to the menu "Fixed value heating circle".

Select menu field "return", set required fixed temperature, save the settings.

NOTICE
If "Fixed value" is set and "Heating limit" is set to YES under the system settings, then the heat pump switches off above the heating limit and the HUP is deactivated.

FIXED TEMPERATURE MIXING CIRCLE 1

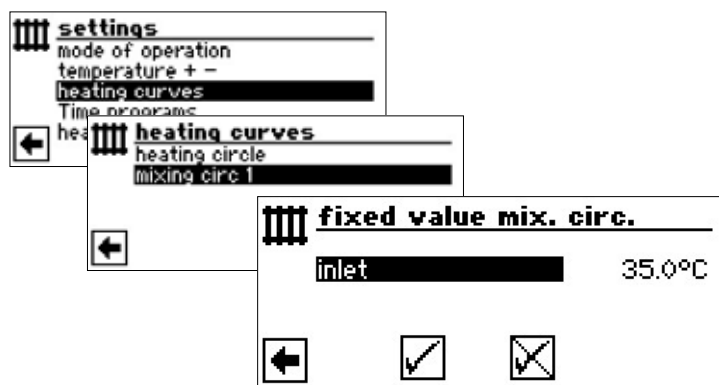

Ist die Option "Festtemperatur" durch die Systemeinstellung eingeschaltet, wechselt der Bildschirm in das Menü "Heizkurven" (von dem ausgehend Sie in die Menüs "Festwert Mischkr. 1" gelangen)

Select menu field "inlet", set required fixed temperature, save the settings.

NOTICE
If "Fixed value" is set and "Heating limit" is set to YES under the system settings, then the heat pump switches off above the heating limit and the HUP is deactivated.

If the option "Fixed temperature" is selected by the system setting, the heating curve will typically appear as follows:

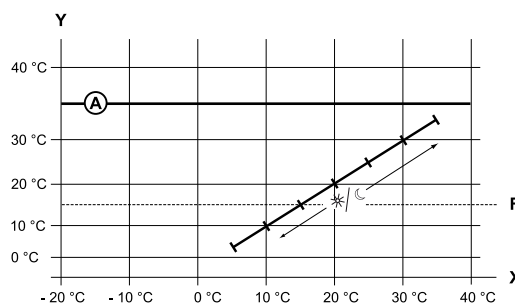

- X External temperature
- Y "Return temperature"
- F Antifreeze
- Ⓐ Fixed temperature (here: + 35 °C)



TIME PROGRAM HEATING

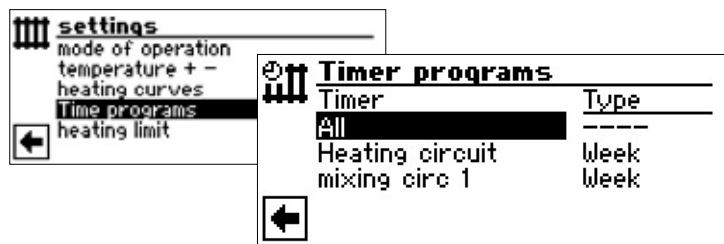

page 11, "Setting the time programs of the heating circle"

HEATING LIMIT

Requirement: the heating limit is set to "yes" under the system settings.

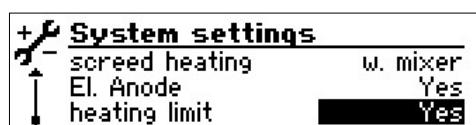

Heating limit = Yes

Heating mode is switched off if the daily mean temperature of the last 24h is higher than the daily meant temperature set as the "heating limit". Requirement: the heating limit is set to "yes" under the system settings.

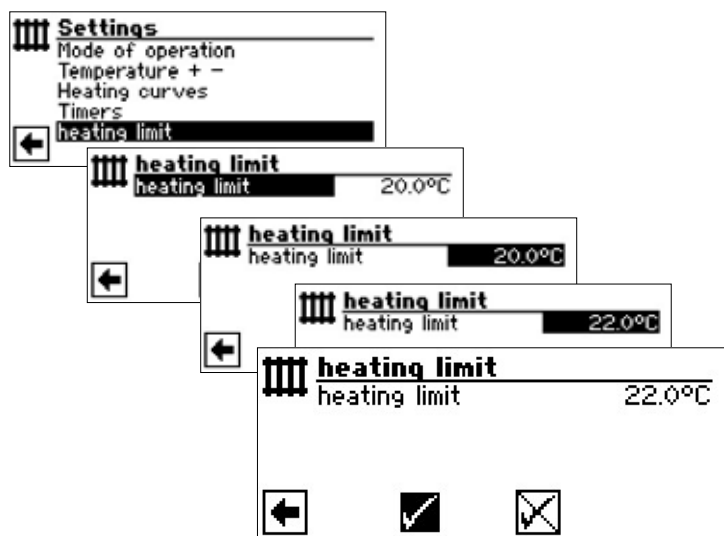

For setting the Heating Limit: part 2 of the controller manual, program area "Service", chapter "Fix system settings"

Program area "Hot water"

SELECT PROGRAM AREA

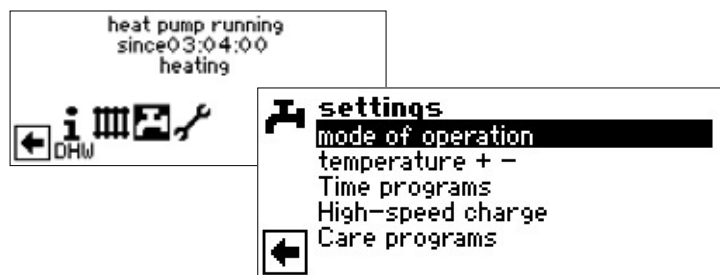

Menu field "Mode of operation"

takes you to the menu "Domestic hot water mode of operation"

Menu field "Temperature + -"

takes you to the menu "Domestic hot water temperature desired value / target temperature" (If the domestic hot water is controlled via a thermostat, this menu field can be omitted.)

Menu field "Time programs"

takes you to the menu "Domestic hot water time programs"

Menu field "High-speed charge"

takes you to the menu "Domestic hot water high-speed charge"

Menu field "Care programs"

takes you to the menu "Care programs"

SETTING THE MODE OF OPERATION "DOMESTIC HOT WATER PREPARATION"

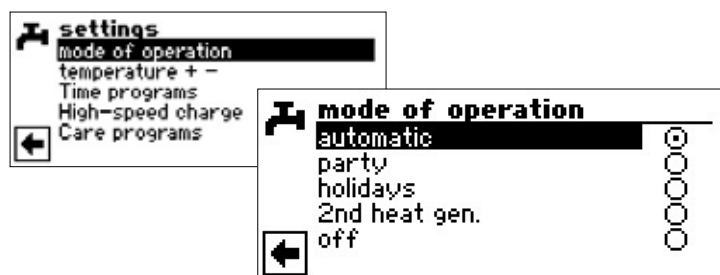

The current mode of operation is highlighted with ⊙

page 14, "Setting the domestic hot water mode of operation"

SET THE DOMESTIC HOT WATER TEMPERATURE

NOTICE

If the domestic hot water preparation is controlled via a thermostat, no temperature fine setting is possible. The menu field "Temperature + -" does not then appear in the screen "Domestic hot water settings".

NOTICE

If a domestic hot water temperature is set which cannot be attained, the heat pump will initially switch to "Error high pressure". This is followed by a self-resetting fault (If heating is required, this will also be operated). After 2 hours have passed, the domestic hot water preparation starts again. Nevertheless, the program of the heating and heat pump regulator automatically lowers the setpoint value



for this by an initial 1 °C. If this setpoint temperature cannot be attained either, the process is repeated until a temperature can be attained.

The set desired value remains unaffected and is displayed unchanged..

HOT WATER TEMPERATURE WITHOUT REHEATING (FACTORY SETTING)

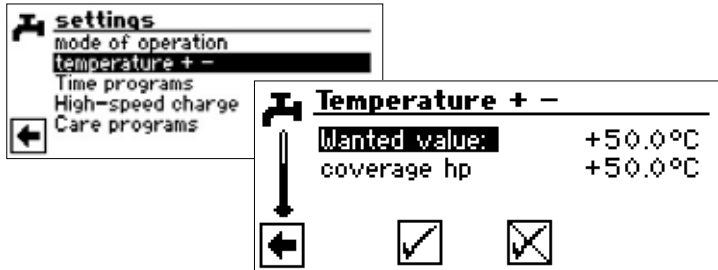

Wunschwert

Required hot water temperature in the hot water storage tank

Select menu field "Desired value" and set required temperature. Einstellung speichern.

Coverage HP

Hot water temperature, which was reached by the heat pump for the last water heating

NOTICE

Depending on the heat source temperatures, this can result in the maximum flow temperatures of the heat pump no longer being able to be reached. Depending on the required temperature, this can mean that the required hot water temperature in the storage tank is also no longer reached.

The heat pump switches off automatically if the use limits are exceeded. The last reached temperature in the storage tank is set as the "coverage hp" and at the same time is the control value for the water heating. As soon as the temperature falls below the "coverage hp" control value by the water heating hysteresis (default 2 K), the water heating starts again. If the last reached "coverage hp" value can be reached, the heat pump tries to approach the required value again, in 0.5 K steps. If the temperature is not reached (even outside the hysteresis) the control value "coverage hp" is reduced by 1 K.

NOTICE

In conjunction with domestic hot water tanks recommended by the manufacturer, your heat pump can generate domestic hot water temperatures which are around 7 K lower than the maximum flow temperature of your heat pump.

HOT WATER TEMPERATURE WITH REHEATING

If water heating with reheating is activated, if the required hot water temperature cannot be reached with the heat pump, a second heat generator is started up until the target temperature is reached.

NOTICE

The "hot water temperature with reheating" function must be enabled first in the "System settings" area:

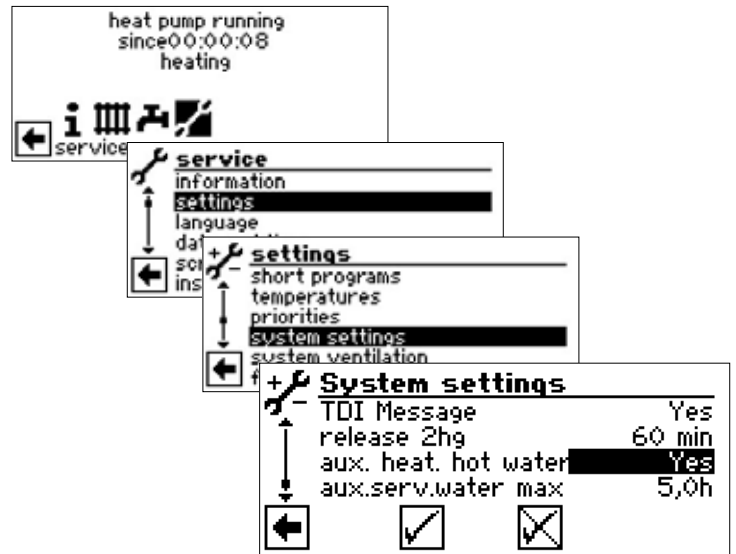

NOTICE

Using the "Hot water temperature with reheating" function can possibly cause higher energy costs. Therefore, after this function has been activated you are asked whether you are prepared to accept the higher energy costs.

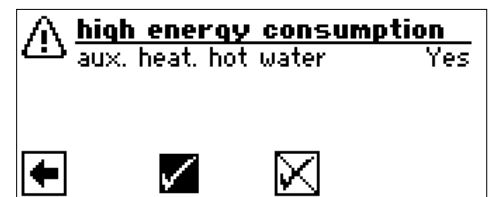

If you confirm this the "Hot water temperature with reheating" function remains activated.

Go to and select to deactivate the "Hot water temperature with reheating" function..

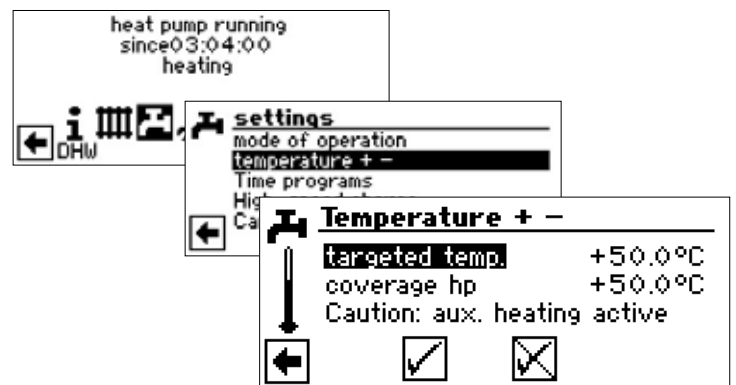

targeted temperature

Target value for the hot water temperature in the domestic hot water storage tank

coverage hp

Hot water temperature reached by the heat pump for the last water heating

NOTICE

If the target temperature cannot be reached with pure heat pump operation, the heat pump switches off prematurely. The difference between the “coverage hp” and “target temperature” is covered by the second heat generator (e.g. electric heating element) in the storage tank:

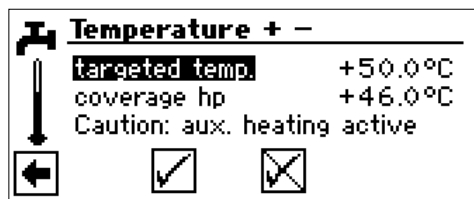

The control value for the water heating is always the parameter “coverage hp”, this means that as soon as the temperature falls below the “coverage hp” control value by the water heating hysteresis (default 2 K), water heating starts again. If the last reached “coverage hp” value can be reached, the heat pump tries to approach the target value again, in 0.5 K steps. If this is not possible, the heat pump switches off and the second heat generator heats the water until the target value is reached.

NOTICE

In conjunction with domestic hot water tanks recommended by the manufacturer, your heat pump can generate domestic hot water temperatures which are around 7 K lower than the maximum flow temperature of your heat pump.

**TIME PROGRAMS
“DOMESTIC HOT WATER PREPARATION”**

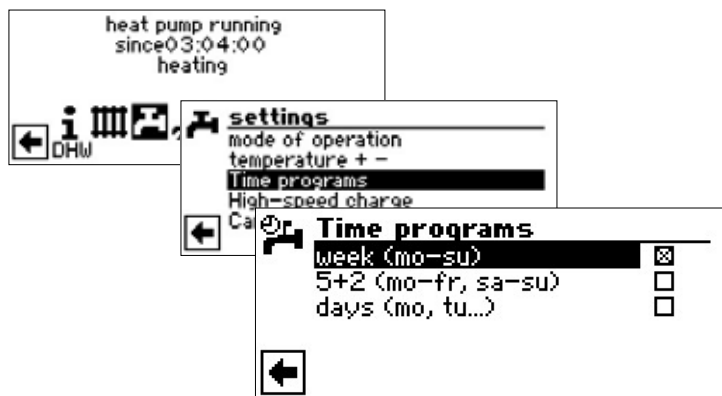

For setting the time programs for domestic hot water preparation refer to chapter “Setting the time programs of the heating circle” (page 11).

NOTICE

When programming, ensure that the time periods which you specify in the area “Time progs” are **off – times**. The domestic hot water preparation is switched off in the time periods entered.

HIGH-SPEED CHARGE

If you require domestic hot water despite active off-time(s), you can select a domestic hot water preparation and then terminate it again via the function “High-speed charge” by bypassing the programmed off-time(s).

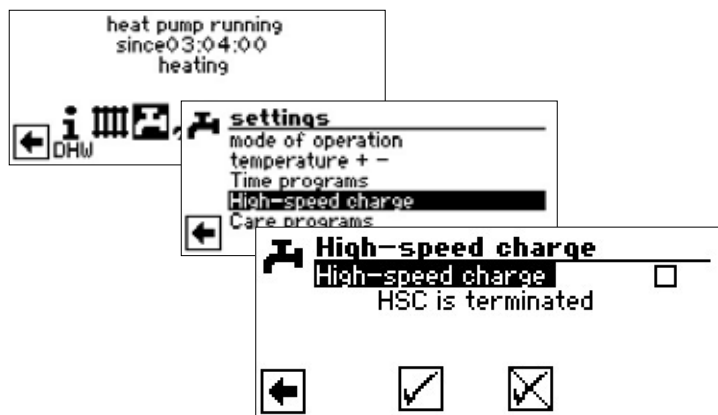

Sie sehen die automatische Statusmeldung des Programms

Select the menu field “High-speed charge”. Save the settings.

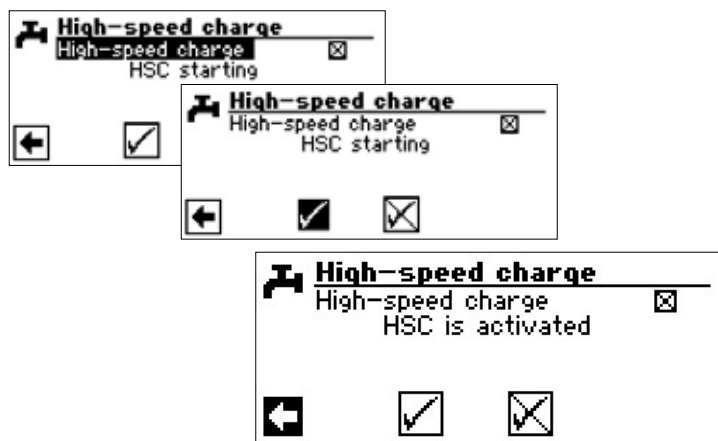

The high-speed charging is terminated analogous via the menu field “Terminate HSC SW”:

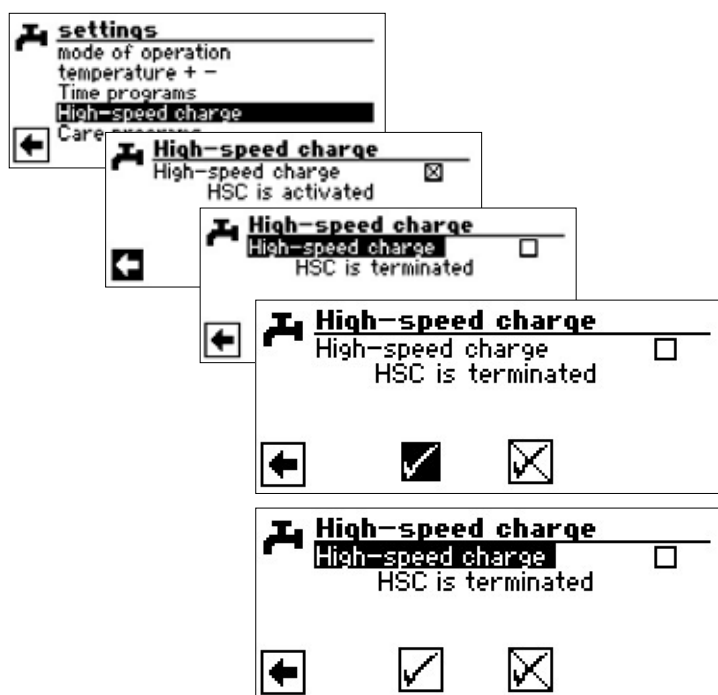



MAINTENANCE PROGRAMS

THERMAL DISINFECTION

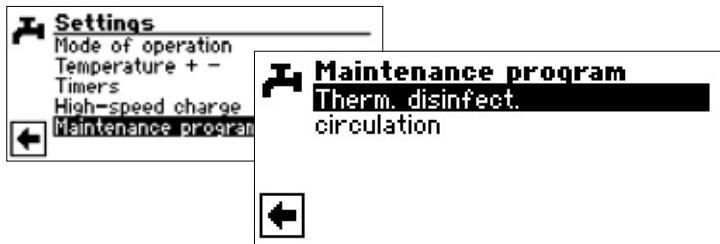

NOTICE

Display "Therm. Disinfection" will only appear if an additional heat generator for domestic hot water preparation has been enabled in the system settings.

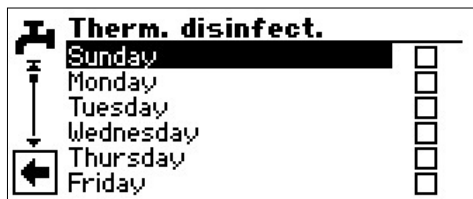

Activate and select day(s) on which a thermal disinfection is to occur.

NOTICE

"Continuous op." means that a thermal disinfection will occur after each domestic hot water preparation. However, the domestic hot water charging always starts at the set hysteresis of the domestic hot water setpoint value

CIRCULATION

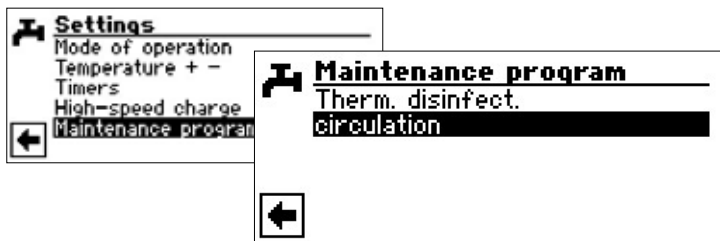

NOTICE

The menu field will only appear if this is correspondingly defined in the program area "Service".

necessary setting: service water 2 = "CP"

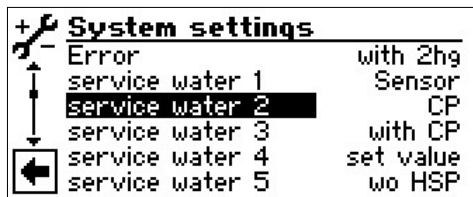

Hot water 2 = ZIP

part 2 of the controller manual, program aera "Service", section "Making settings".

The circulation pump can be configured by setting time programs and impulse.

TIME SWITCHES

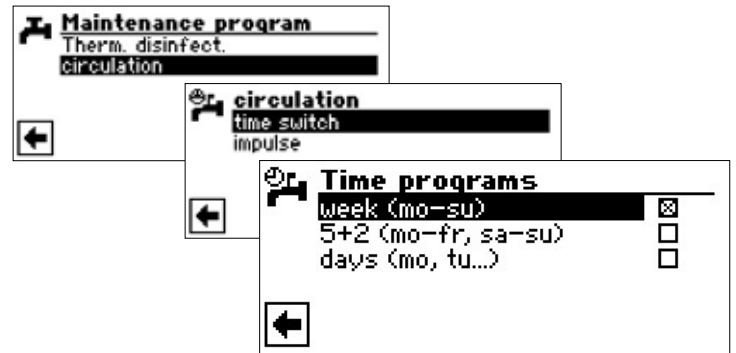

Use the time programs to specify the times during which the circulation pump is to run.

For the exact procedure used to set the times, please refer to chapter "Setting the time programs of the heating circle" (page 11).

IMPULSE

Under the time program item, you can decide how long the pump is to be switched on and off during the released time periods.

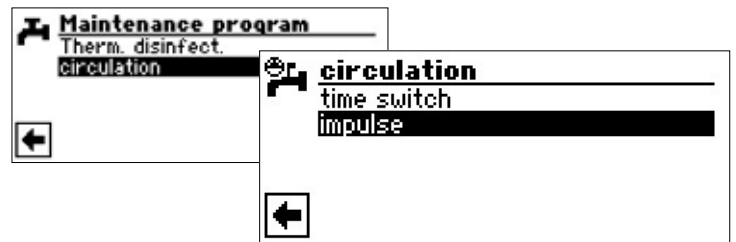

Example 1:

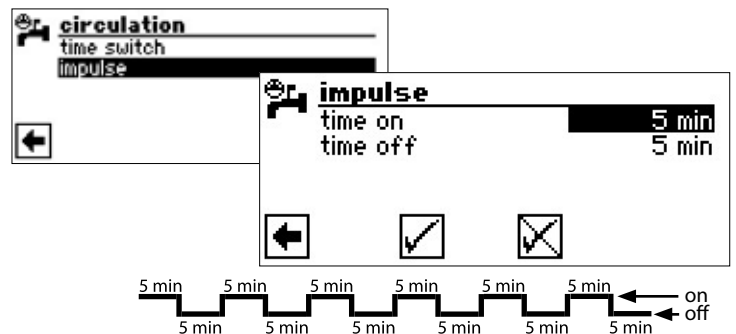

Example 2:

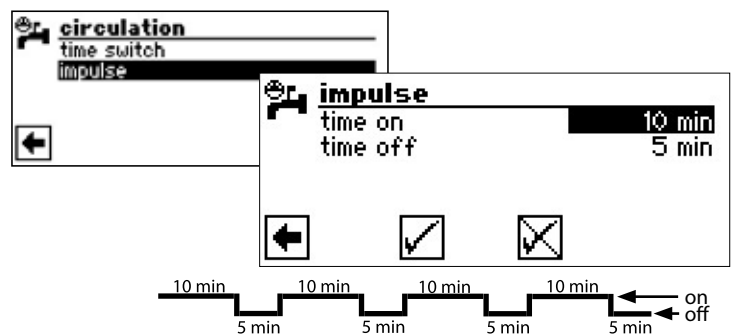

If the "Time off" setting is set to 0 minutes, the circulation pump will be switched on permanently during the released time periods.



❄️ Program area “Cooling”

! ATTENTION

Only select the program area “Cooling” if a cooling circle mixer is connected in conjunction with a brine/water heat pump or a LWD.

! ATTENTION

If a cooling circle mixer is connected, it is imperative to select the program area “Cooling”, as otherwise malfunctions will occur in the mixer connected.

The program area “Cooling” must be set by authorised service personnel during commissioning.

necessary setting for brine/water-Heatpumps:

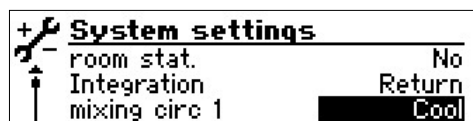

Mixing circle 1 = cool

necessary setting for reversiblen LWD-Heatpumps:

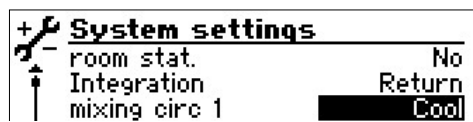

Einbindung = Return

Mixing circle 1 = cool

part 2 of the controller manual, program aera “Service”, section “Making settings”.

If the passive cooling function is set, the symbol for the program area ❄️ will appear in the navigation screen:



SELECT PROGRAM AREA

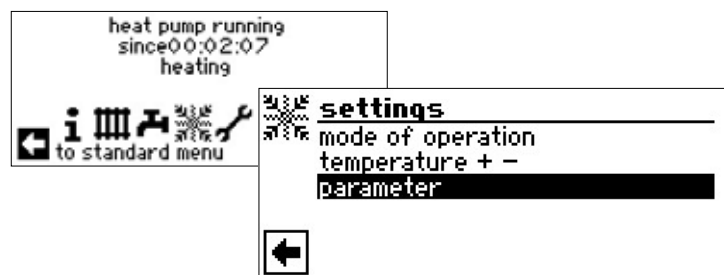

Menu field “mode of operation”

leads to the menu “Cooling mode of operation”

Menu field “Temperatur + -”

leads to the menu “Cooling Temperature”

Menu field “Parameter”

leads to the menu “Cooling Parameter”

SETTING THE MODE OF OPERATION “COOLING”

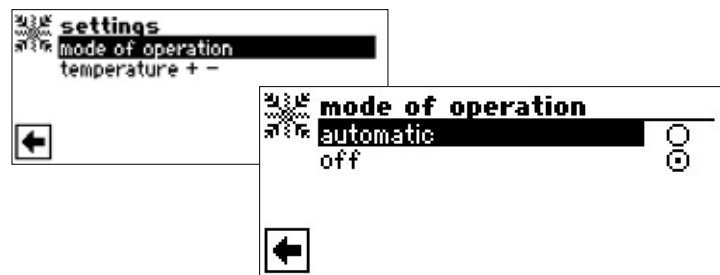

The current mode of operation is highlighted with ⊙ :

Automatic

Switches the passive cooling function on independently of the external temperature release.

Off

Switches the passive cooling function off.

i NOTICE

Only BW/WW heat pumps: If the passive cooling function has been switched on, the program of the heating and the heat pump regulator will automatically set the heating to the mode of operation “Off”.

The reverse applies:

If the heating has been switched on, the program of the heating and heat pump regulator will automatically set the passive cooling function to the mode of operation “Off”.

SETTING THE COOLING TEMPERATURE

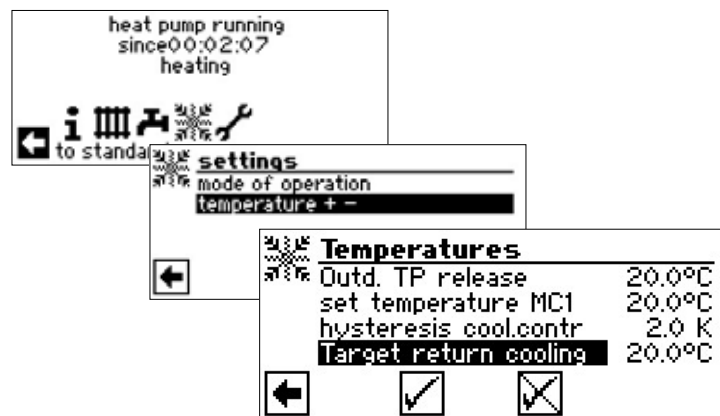

AT-Releasee

Required Outdoor Temperature release

Set temperature mixing circle MK1

Required Set temperature for Cooling

The setpoint value determines the control variable for the activated cooling mixer.

Hysteresis CC

Menu line: “Cooling contr.”

For reversible LWDs.

Target return cooling

Menu line: “Target return cooling”

For reversible LWDs can be set between 13°C and 25°C:

Activate the menu fields set required temperature. Save the settings.



SET PARAMETER

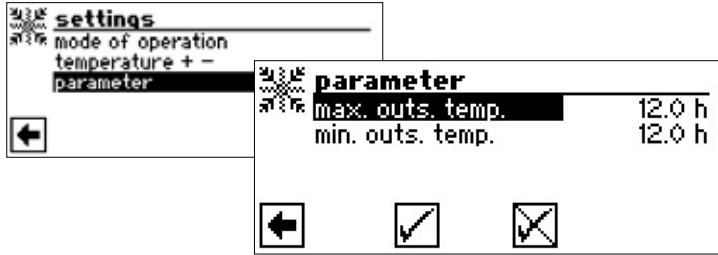

AT-exceeded

Menu line "Outside temperature-exceeded"

AT-undershot

Menu line "Outside temperature-undershot"

Set required time (in hours). Save settings.

NOTICE

Cooling will not set in unless the temperature has risen above TOut rel. for more than 12 hours or once by 5 K. Cooling is switched off when the temperature has fallen below TOut rel. for more than 12 hours.

Only BW/WW heat pumps: The cooling function will only be enabled if the brine inlet temperature is $> 3\text{ }^{\circ}\text{C}$.

The set setpoint temperature defines the flow temperature of the heat pump during cooling.

Program area "Parallel connection"

NOTICE
Parallel operation is not possible with output controlled air/water heat pumps and with hydraulic module 2!

The parallel connection is used for connecting four heat pumps with one another in order to allow them to be connected to a shared heating system.

One of these heat pumps (master HP) takes over the task of controlling the entire heating system.

An outdoor sensor and the associated control sensor (return sensor) of the heating system must be connected to this heat pump.

Also, only this heat pump will be able to activate a second heat generator (2 hg).

Any slave heat pump of the system can be used for domestic hot water preparation. To prepare domestic hot water using a heat pump connected in parallel, connect the associated domestic hot water sensor to the corresponding heat pump. Also required is the connection of the electrical supply contact to the heat pump! While the heat pump is preparing domestic hot water, it is excluded from the control compound and not energised by the master HP.

NOTICE
Parallel operation is not possible unless all integrated heat pumps are fitted with the same number of compressors!

NOTICE
The el. sup. blockade must always be connected to the master heat pump and the heat pump responsible for domestic hot water preparation!

NOTICE
There is only ONE master per parallel connection.

The individual stages of a parallel connection are activated such that the first compressor will always be the first to run before the second compressor of a heat pump is energised.

The individual compressor stages cannot be locked depending on the outdoor temperature.

The master HP will always energise the stage with the lowest running time based on the operation hours of the individual devices.

CONNECTION

The heat pumps are connected to one another via the Ethernet interface and a hub or "switch" (not included in the scope of delivery!).

Example 1:

4 heat pumps for heating, 1 heat pump is responsible for domestic hot water

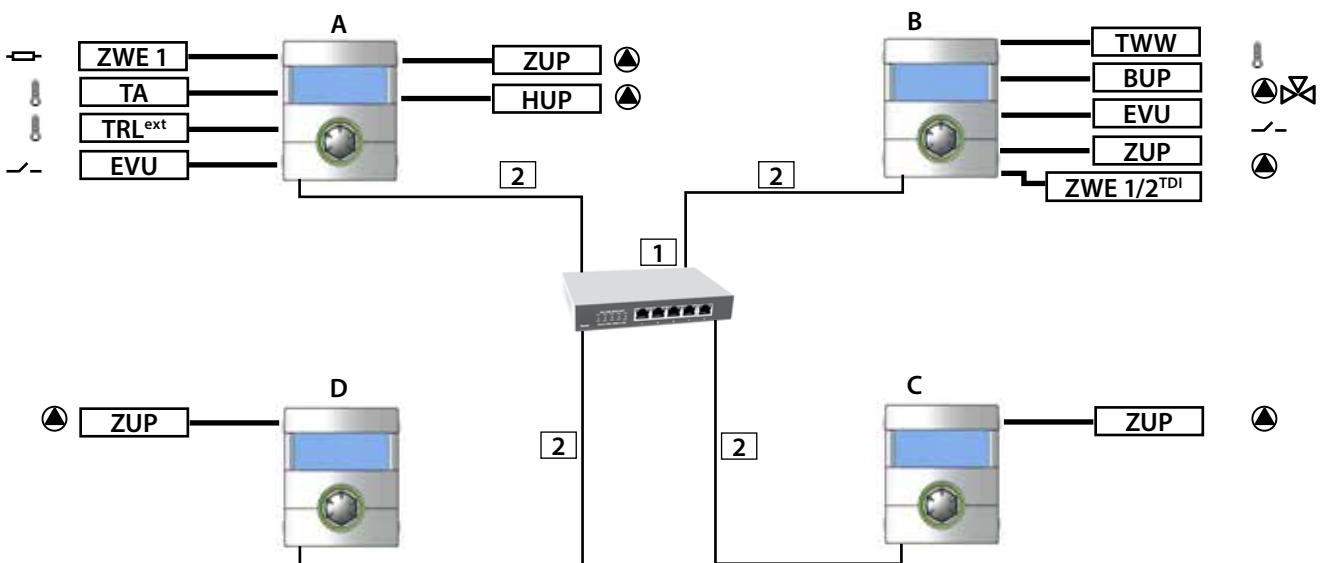

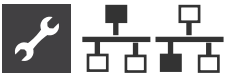

Example 2:

2 heat pumps used only for heating

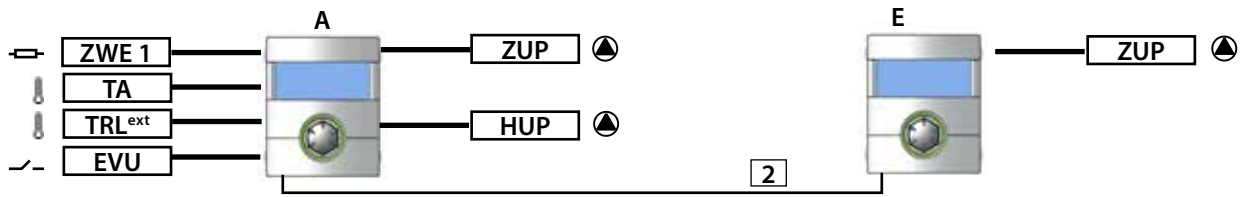

Example 3:

2 heat pumps for heating mode, 1 heat pump is responsible for domestic water heating

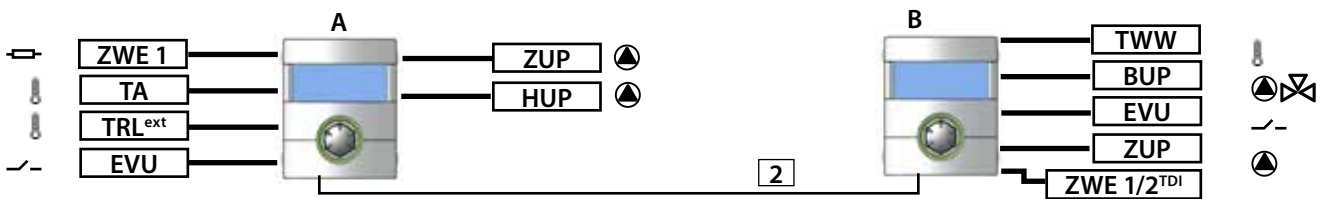

TWW	Domestic hot water temperature sensor
ZWE 1	Second heat generator 1
TA	External senso
TRL ^{ext}	External return flow sensor
EVU	Release signal electric suppl.
BUP	Domestic hot water pump
ZUP	Additional circulation pump
HUP	Heating circulation pump
ZWE 1/2 ^{TDI}	Second heat generator 1 oder 2 (only possible for "Thermal disinfection")

1 Hub or switch with 4 ports (RJ-45, 10 Base-T / 100 Base-Tx)

2 Patch cable RJ-45 (up to 20m)

A	Heat pump Master	(in this case only heating)
B	Heat pump Slave 1	(heating and domestic hot water)
C	Heat pump Slave 2	(in this case only heating)
D	Heat pump Slave 3	(in this case only heating)
E	Heat pump Slave 1	(only heating)

SELECT PROGRAM AREA

The program area "Parallel connection" must be set by authorised service personnel during commissioning.

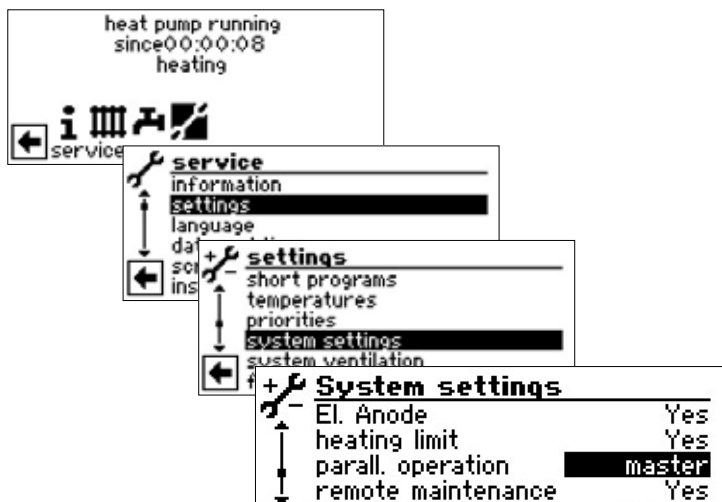

Menu field "Parallel Connection"

The heatpump is either defined as "Master" or as "Slave".

Is the heatpump defined as "Master" you can see this symbol in the navigation screen



Is the heatpump defined as "Slave" you can see this symbol in the navigation screen

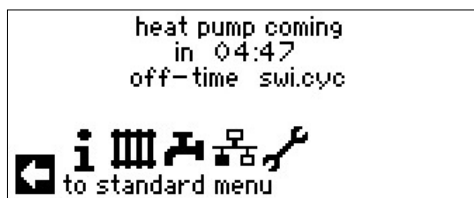

IP-ADDRESS

Establishing the connection requires that the DHCP server be enabled and the heat pumps have different IP addresses. The subnet mask must be the same.

page 33, "DHCP Server"

SET OR CHANGE THE IP ADDRESS

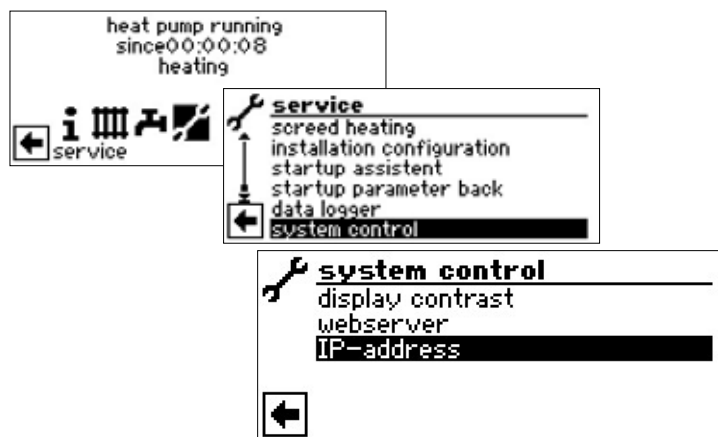

Example:

Default IP setting for the heat pump Master:

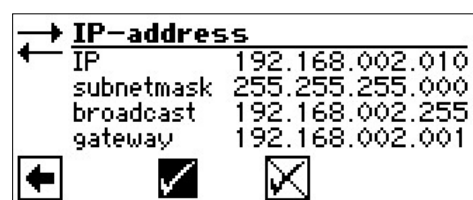

Menu field "IP"

IP-Address of the Heatpump-Masters

Menu field "Subntzmsk."

IP-Address must be the same for all heat pumps

Menu field "Broadcast"

IP-Address must be the same for all heat pumps

Menu field "Gateway"

IP-Address must be the same for all heat pumps

Default IP setting for the heat pump -Slave 1:

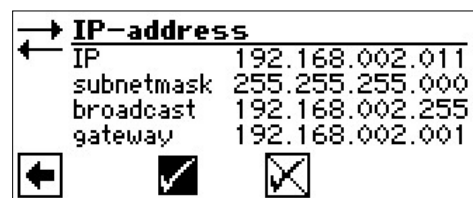

Menu field "IP"

IP address of the heat pump slave 1. The first three number blocks (here: 192.168.002) must correspond to the first three number blocks of the heat pump master. The fourth number block (here: 011) must differ from heat pump to heat pump.

In a system with 2 or 3 heat pump slaves, the last three digits must also be set as unique numbers (different from one another)

Menu field "Subntzmsk."

IP-Address as heatpump-Master

Menu field "Broadcast"

IP-Address as heatpump-Master

Menu field "Gateway"

IP-Address as heatpump-Master

NOTICE

The first three number blocks of the IP addresses must always be identical (as in the illustrated example: 192.168.002). The fourth number block must always differ from heat pump to heat pump (in the illustrated example: 010 for heat pump master, 011 for heat pump slave 1)! The subnet mask, broadcast and gateway number must be the same for all heat pumps!

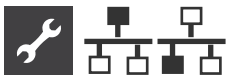

EXTERNAL RETURN FLOW SENSOR

One parallel connection usually has one single buffer tank for all heat pumps. In this case, the external return flow sensor must be installed in this buffer tank and connected to the master heat pump.

 part 2 of the controller manual, Program area, chapter "Montage and installation of the sensors".

SETTING ON THE MASTER HEAT PUMP

SEARCH FOR THE HEATPUMP SLAVES

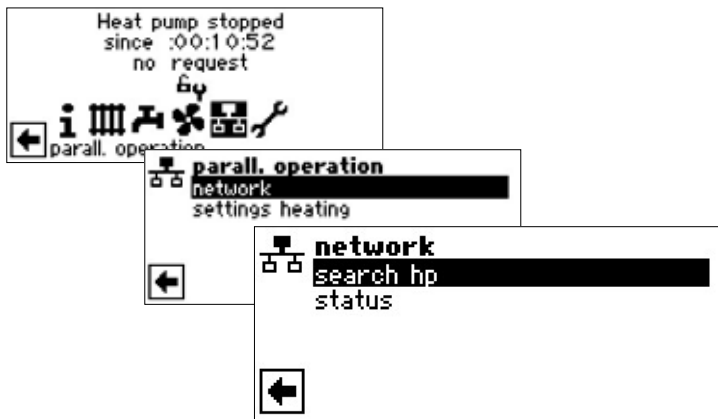

Menu field "search HP"

Selecting "Search for HP" will initiate a search throughout the network.

NOTICE

This requires that all heat pumps that are supposed to work in parallel be switched on and all IP addresses set correctly!

As soon as the search is finished the IP addresses of all heat pumps integrated in the network are displayed:

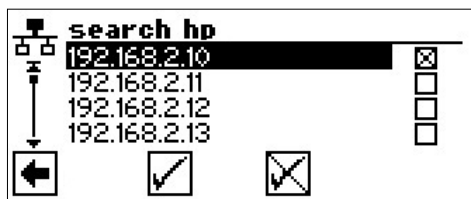

192.168.2.10

Exemplary IP address, which is assigned here to the heat pump-Master

192.168.2.11

Exemplary IP address, which is assigned here to the heat pump-Slave 1t

192.168.2.12

Exemplary IP address, which is assigned here to the heat pump-Slave 2

192.168.2.13

Exemplary IP address, which is assigned here to the heat pump-Slave 3

Select the slave heat pumps that are supposed to work in parallel and confirm.

STATUS OF THE MASTER HEAT PUMP

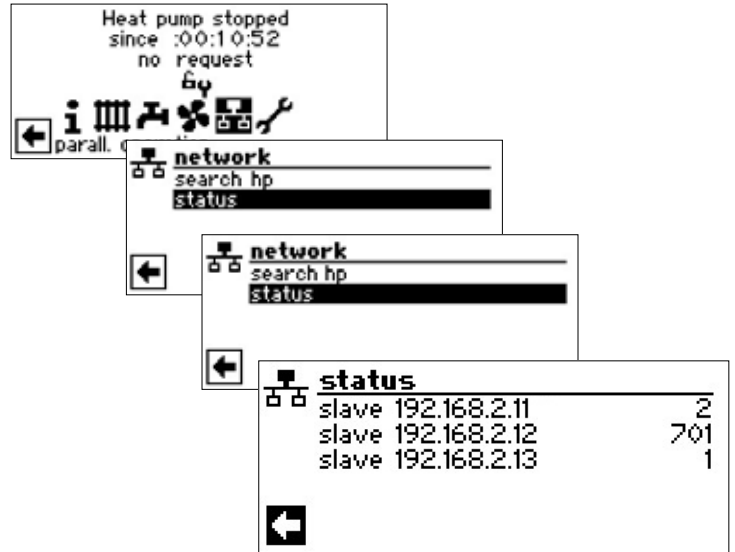

Menü "Status"

This menu shows which information the master heat pump receives from the individual slave heat pumps

Mögliche Anzeigen

0	no compressor activ
1	one compressors activ
2	two compressors aktiv
7xx	error: operation of the heatpump-Slave

 Error codes see : art 2 of the controller manual, Overview (appendix) "Error Diagnosis / Error messages"

SETTING THE HEATING

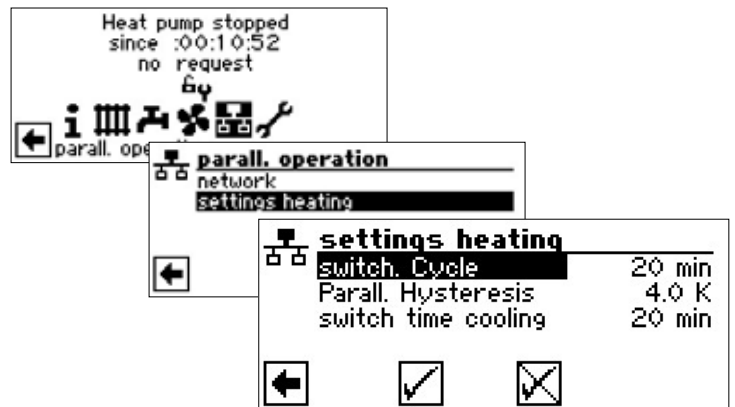

Menu field "Switch Cycle"

means heating control time. This time defines at what interval the heating is supposed to switch to the next higher / lower bivalent level (compressor switch-on/shut-off).

This value should not be set to less than 10 minutes for 2 heat pumps.

If you set 20 min., it would take 20 minutes until the second compressor stage would be energised following the first compressor stage if a corresponding request is received.

The request is determined by the setpoint and actual return temperature of the master heat pump. To see how much of the heating control time has expired, refer to Information-Timings.

Menu field “Parallel Hysteresis”

In addition to the heating regulator hysteresis (under: Service / Settings / Temperatures), there is also a parallel hysteresis for parallel connections. This hysteresis must always be greater than the heating regulator hysteresis of the master heat pump. The purpose of this second hysteresis setting is to cut in half the heating control time that will expire before the next switch-on/switch-off if this hysteresis is exceeded. This allows for a quicker control response if the difference between setpoint and actual temperature is too great.



For details of setting the hysteresis for the heating controller outside of parallel operation, see: part 2 of the controller manual, program area “Service”, chapter “Setting temperatures”

Menu field “Switch Time Cooling”

means cooling controller time. This time defines at what interval the heating is supposed to switch to the next higher / lower bivalent level (compressor switch-on/shut-off).

This value should not be set to less than 10 minutes for 2 heat pumps.

If you set 20 min., it would take 20 minutes until the second compressor stage would be energised following the first compressor stage if a corresponding request is received.

The request is determined by the temperatures of the master heat pump.



Program area "Service"

CALLING UP SHORT PROGRAMS

The short programs serve to make service work easier.

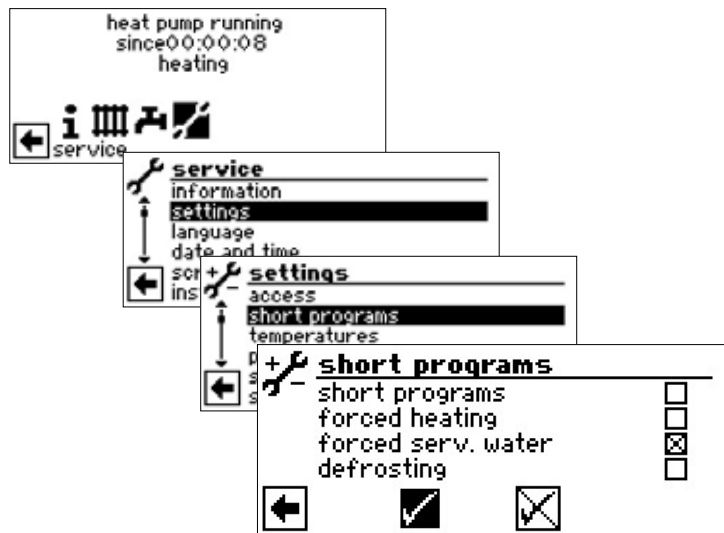

Short programs

Shortens the switching cycle stop and releases the heat pump.

Forced Heatin

Program settings are ignored. Heating requirement up to high pressure. After a high pressure fault, the menu field "Forced heating" is automatically deselected and reset.

Forced serv. water

Function analogous to "Forced heating".

Defrosting

The defrost function of the heat pump can be tested with this (only L/W devices).

DETERMINING PRIORITIES



priority is determined by the sequence of numbers.



NOTICE

Hot water – as in the example – has top priority in the factory setting.

If you wish to give the heating priority, Menüfeld "Warmwasser" aktivieren und Priorität ändern. Priorität für "Heizung" wird automatisch auf 1 gesetzt.

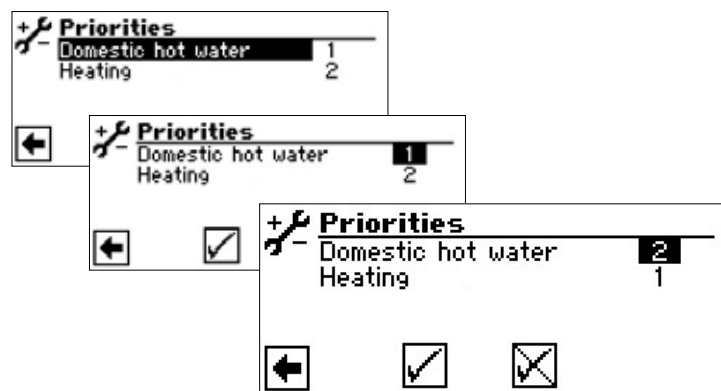

Save settings.



DATA LOGGER

The controller is equipped with a data logger which records the data of the heat pump for a period of 48 hours (temperatures, inputs/outputs). You can save this data to a USB stick. To do so, insert the USB stick into the controller and use the menu item data logger to save the data to the USB stick.

An authorised customer service or fitter can start a permanent data logger function using his or her password access. If the USB stick is inserted, the data including date and time will then be stored automatically every 48 hours.

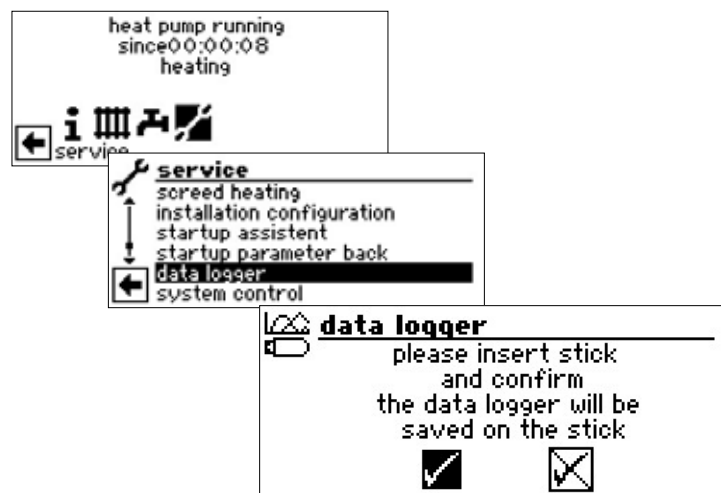

NOTICE

Please remember to save the data logger to the USB stick before removing the USB stick from the control element. You will otherwise lose the most recent values.



CONTROL PANEL

WEB SERVER

The left socket at the bottom of the control element can be used to connect to a computer or a network, enabling the heating and heat pump regulator to be controlled remotely from there.

This requires the laying of a screened network cable (category 6) through the unit during the electrical connection work. If this network cable is available, insert the network cable's RJ 45 plug into the left socket of the control element..



The "Web server" function allows you to use a computer and an Internet browser to control the heating and heat pump regulator..

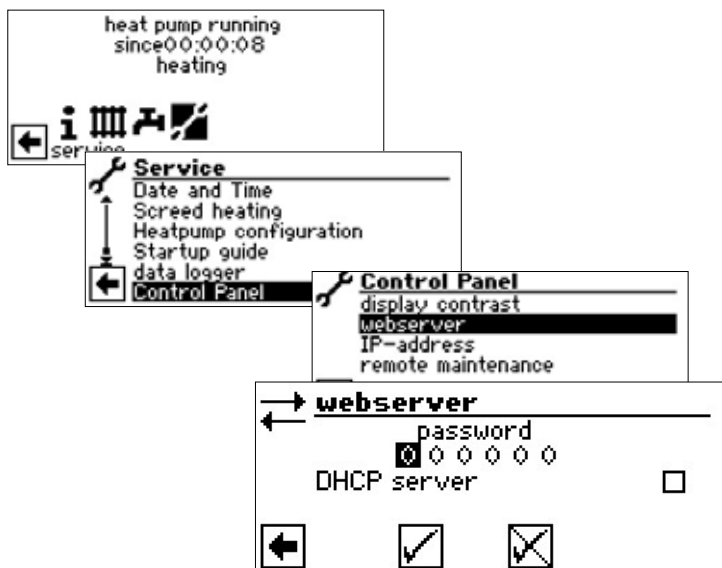

The screen switches to the "Web server" menu. Start by entering the 6-digit numeric password to unlock data input access. You will need this password later to register the computer with the controller. If you enter an incorrect numeric password, you will only be able to read data, but not make any changes.

DHCP SERVER

If the computer is connected directly to the heating and heat pump regulator, enable the menu item "DHCP Server".

The computer connected as a DHCP client will automatically be assigned an IP address.

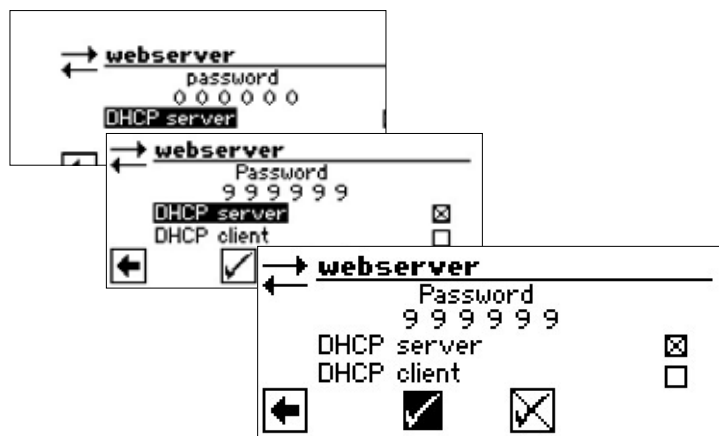

NOTICE

The connected computer must operate as a "DHCP Client". This will result in the computer receiving all necessary connection data automatically from the DHCP server of the heating and heat pump regulator.

In the event of any connection problems, check the network settings of the operating system installed on your computer and adjust the settings if necessary.

DHCP CLIENT

If the heat pump controller is connected to a network with a DHCP server, the controller can be assigned an IP address by this server (e.g. router). The DHCP Client point must be activated for this.

Following a restart, the IP address assigned is displayed in the "IP address" menu.

NOTICE

If the heat pump controller is connected to a network with a DHCP server, the controller can be assigned an IP address by this server (e.g. router). The DHCP Client point must be activated for this.

Following a restart, the IP address assigned is displayed in the "IP address" menu.

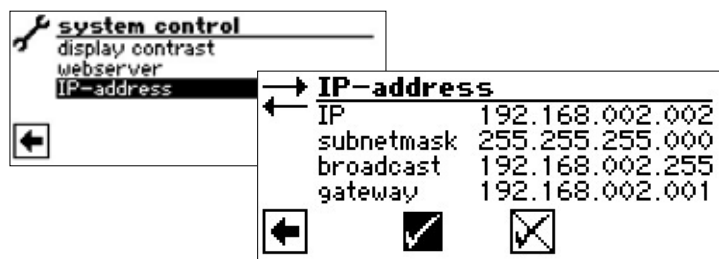

IP	IP address of the heating and heat pump regulator
Subntsmk.	Subnet mask
Broadcast	Adress Broadcast
Gateway	Gateway address of the connected router)

If "DHCP Server" or "DHCP Client" is enabled, you will only be read, but not make any changes to the data.

To gain access to the heating and heat pump regulator from the connected computer, open a Web browser and enter "http://" into the address line followed by the number of your heating and heat pump regulator shown under "IP".



If the computer is connected via a router and, thus, the “DHC Server” of the heating and heat pump regulator is disabled, you will have to adjust the IP address as well as all other entries (subnet mask, broadcast, gateway) shown on the screen of the heating and heat pump regulator to the address areas of your router.

Example:

The IP address of the connected router (= gateway) is 192.168.2.1, and the number of the subnet mask is 255.255.255.0.

You will then have to enter and save the following address information in the heating and heat pump regulator:

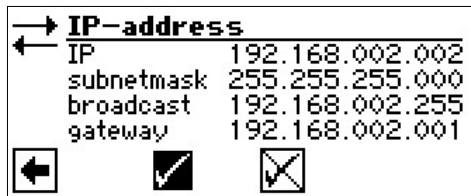

NOTICE

Enter an address between 192.168.002.002 and 192.168.002.254 under the menu item “IP”. The address you enter must not have been assigned to another device managed by the connected router.

NOTICE

The JVM (Java Virtual Machine) is available as a plug-in for your Web browser. To download the JVM Web browser plug-in from the Internet, log on to <http://www.java.com>.

REMOTE MAINTENANCE

The “Remote maintenance” function enables direct access to the the heating and heat pump regulators on the remote maintenance server of the manufacturer.

In order to be able to use “Remote maintenance”, the following prerequisites must be fulfilled:

- A special contract with the manufacturer has been negotiated.
- The heating and heat pump regulator has access to the internet with open port 21 via a broadband connection (DSL) and a router..
- The commissioning of the heat pumps will be handled by the manufacturer’s customer service representatives.
- The manufacturer makes available a completed application form for remote maintenance.

NOTICE

Remote maintenance is an additional service feature made available by the manufacturer at an additional cost.

NOTICE

All settings that are related to the “Remote maintenance” function, may only be handled by authorised service personnel.

SWITCH ON THE REMOTE MAINTENANCE FUNCTION

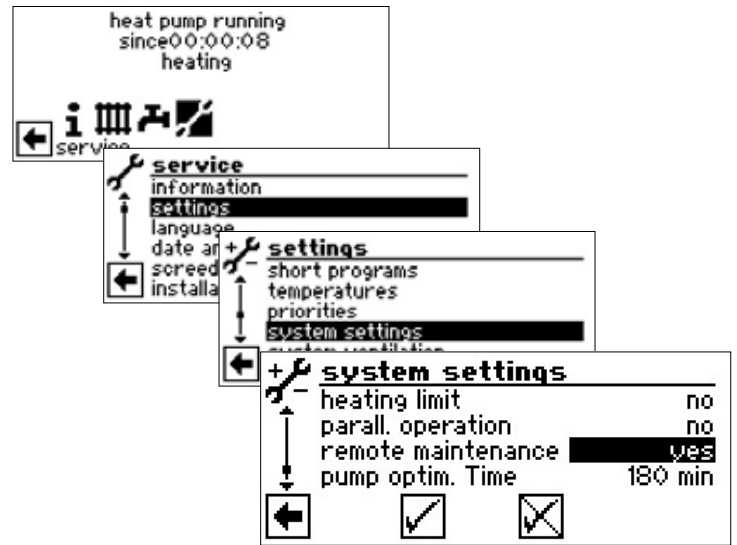

ADJUST THE REMOTE MAINTENANCE FUNCTION

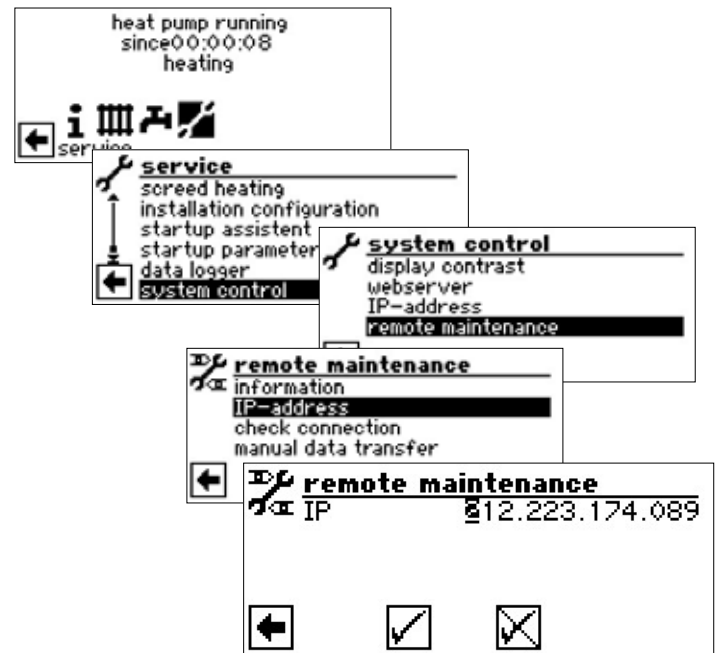

Enter the IP address of the remote maintenance server here (currently: 212.223.174.089)

NOTICE

Once successfully connected with the remote maintenance server, the IP address may no longer be changed. The router must be set up as a gateway.

page 33, “Webserver”

CHECK CONNECTION

NOTICE

Checking the connection is essential at the time of initial adjustment.

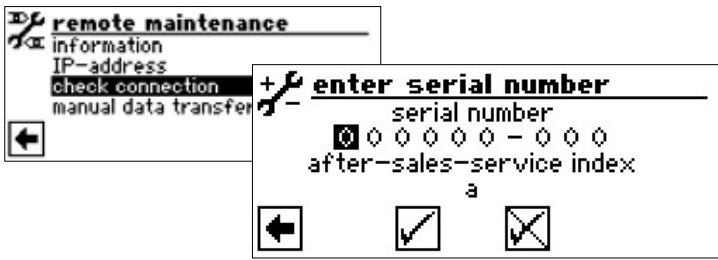

Enter the serial number of the heat pump...

NOTICE

A connection with the remote maintenance server is only possible if the serial number of your heat pump is correctly entered.

The heat pump serial number can be found on the rating plate attached to the housing of the heat pump.

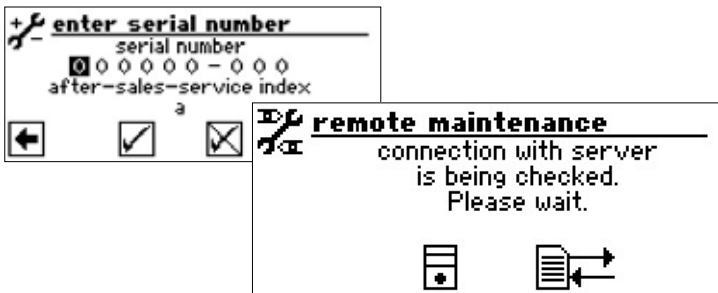

If errors occur during the checking of the connection, a corresponding warning will appear on the screen of heating and heat pump regulator:



page 35, "Error causes with connection problems"

MANUAL DATA TRANSFER

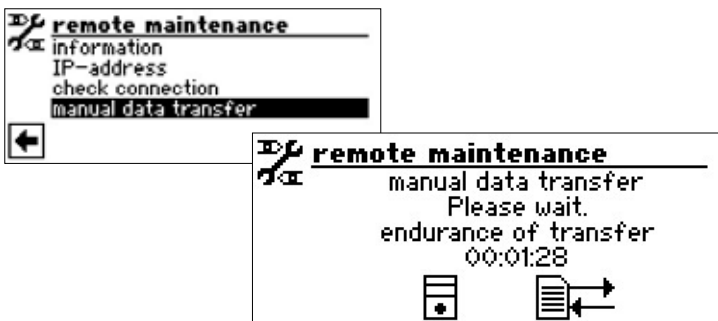

If connection problems arise, the following message will appear on the screen:

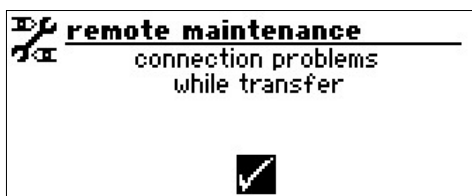

page 35, "Error causes with connection problems"

ERROR CAUSES WITH CONNECTION PROBLEMS

If a connection with the remote maintenance server is not possible, the causes may include:

- The heating and heat pump regulator has no connection to the internet.
- The standard gateway in the "System control / IP address" is not correctly set up.
- Port 21 is not activated for the heating and heat pump regulator.
- The IP address of the heating and heat pump regulator is not adjusted to conform to your local network.

If connection problems arise, check all settings associated with "Remote maintenance", "Web server", and "System control / IP address". Correct the settings as needed.

If, thereafter, a connection with the remote maintenance server is still not possible, contact the customer service representatives of the manufacturer.

INFORMATION ON THE REMOTE MAINTENANCE FUNCTION

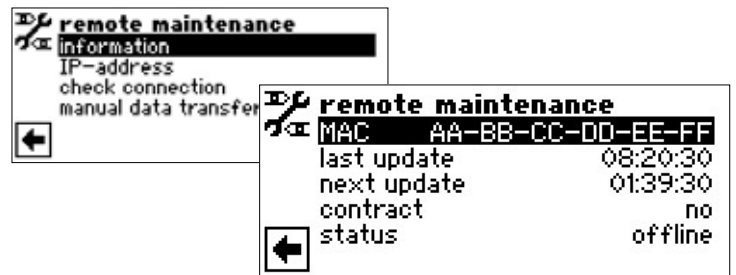

MAC	MAC address of the controller Data must be shared with the manufacturer by the time the contract is signed.
last update	elapsed time since the last activation of the remote maintenance
next update	time until the next automatic activation of the remote maintenance
contract	description of the closed remote maintenance contract
status	status of the remote maintenance
Offline	standard display (is most often displayed)
Online	connection to the remote maintenance server is established and active



ait-deutschland GmbH
Industriestraße 3
D-95359 Kasendorf

E info@alpha-innotec.de
W www.alpha-innotec.de



alpha innotec – an ait-deutschland GmbH brand